

emas[®]

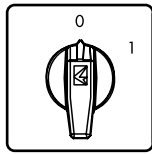

ROTARY CAM SWITCHES



"0-1" On-Off Cam Switches - 60°

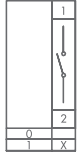

PSA020AK131S

Code	Poles	Rated Thermal Current (A)	Enclosure	Key Operated	Quick Installation	Key Operated & Quick Installation With Plate	Lockable Handle With Plate
PSA010AK131S	1 Faz	10	PSK11	✓	✓	✓	✓
PSA016AK131S	1 Faz	16	PSK11	✓	✓	✓	✓
PSA020AK131S	1 Faz	20	PSK11	✓	✓	✓	✓
PSA025AK131S	1 Faz	25	PSK11	✓	✓	✓	✓
PSA032AK131S	1 Faz	32	PSK21				
PSA040AK131S	1 Faz	40	PSK21				
PSA050AK131S	1 Faz	50	PSK31				
PSA063AK131S	1 Faz	63	PSK31				
PSA080AK131S	1 Faz	80	-				
PSA120AK131S	1 Faz	120	-				

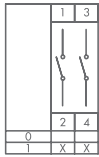

PSA020AK231S

PSA010AK231S	2 Faz	10	PSK11	✓	✓	✓	✓
PSA016AK231S	2 Faz	16	PSK11	✓	✓	✓	✓
PSA020AK231S	2 Faz	20	PSK11	✓	✓	✓	✓
PSA025AK231S	2 Faz	25	PSK11	✓	✓	✓	✓
PSA032AK231S	2 Faz	32	PSK21				
PSA040AK231S	2 Faz	40	PSK21				
PSA050AK231S	2 Faz	50	PSK31				
PSA063AK231S	2 Faz	63	PSK31				
PSA080AK231S	2 Faz	80	-				
PSA120AK231S	2 Faz	120	-				

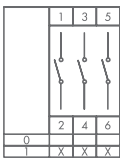

PSA020AK331S

PSA010AK331S	3 Faz	10	PSK11	✓	✓	✓	✓
PSA016AK331S	3 Faz	16	PSK11	✓	✓	✓	✓
PSA020AK331S	3 Faz	20	PSK11	✓	✓	✓	✓
PSA025AK331S	3 Faz	25	PSK11	✓	✓	✓	✓
PSA032AK331S	3 Faz	32	PSK21				
PSA040AK331S	3 Faz	40	PSK21				
PSA050AK331S	3 Faz	50	PSK31				
PSA063AK331S	3 Faz	63	PSK31				
PSA080AK331S	3 Faz	80	-				
PSA120AK331S	3 Faz	120	-				

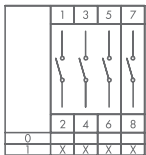

PSA020AK431S

PSA010AK431S	4 Faz	10	PSK11	✓	✓	✓	✓
PSA016AK431S	4 Faz	16	PSK11	✓	✓	✓	✓
PSA020AK431S	4 Faz	20	PSK11	✓	✓	✓	✓
PSA025AK431S	4 Faz	25	PSK11	✓	✓	✓	✓
PSA032AK431S	4 Faz	32	PSK21				
PSA040AK431S	4 Faz	40	PSK21				
PSA050AK431S	4 Faz	50	PSK31				
PSA063AK431S	4 Faz	63	PSK31				
PSA080AK431S	4 Faz	80	-				
PSA120AK431S	4 Faz	120	-				

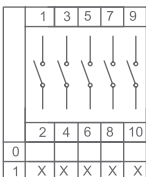

PSA010AK531S	5 Kutup	10	PSK12	✓	✓	✓	✓
PSA016AK531S	5 Kutup	16	PSK12	✓	✓	✓	✓
PSA020AK531S	5 Kutup	20	PSK12	✓	✓	✓	✓
PSA025AK531S	5 Kutup	25	PSK12	✓	✓	✓	✓
PSA032AK531S	5 Kutup	32	PSK22				
PSA040AK531S	5 Kutup	40	PSK22				
PSA050AK531S	5 Kutup	50					
PSA063AK531S	5 Kutup	63					
PSA080AK531S	5 Kutup	80					
PSA120AK531S	5 Kutup	120					

* Can be supplied with Red-Yellow head w/o extra charge, in this case please replace "S" at the end with "E".

** 10-25A Cam Switches can be supplied with big frame (64 x 64) with extra charge, In this case please replace the "S" at the end with "B".

***Please replace "S" letter at the end of the code with "SAQ" for Key Operated & Quick Installation With Plate Model (with extra charge)

**** Please replace "S" letter at the end of the code with "K" for Lockable Handle model (with extra charge)

***** Please replace "S" letter at the end of the code with "SQ" for Quick Installation model (with extra charge)

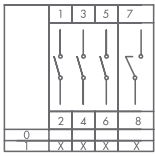

PSA020AK831S

"0-1" On-Off Cam Switches - 60°

Code	Poles	Rated Thermal Current (A)	Enclosure	Key Operated	Quick Installation	Key Operated & Quick Installation With Plate	Lockable Handle With Plate
PSA010AK831S	3 Poles+Neutral	10	PSK11	✓	✓	✓	✓
PSA016AK831S	3 Poles+Neutral	16	PSK11	✓	✓	✓	✓
PSA020AK831S	3 Poles+Neutral	20	PSK11	✓	✓	✓	✓
PSA025AK831S	3 Poles+Neutral	25	PSK11	✓	✓	✓	✓
PSA032AK831S	3 Poles+Neutral	32	PSK21				
PSA040AK831S	3 Poles+Neutral	40	PSK21				
PSA050AK831S	3 Poles+Neutral	50	PSK31				
PSA063AK831S	3 Poles+Neutral	63	PSK31				
PSA080AK831S	3 Poles+Neutral	80	-				
PSA120AK831S	3 Poles+Neutral	120	-				

* Can be supplied with Red-Yellow head w/o extra charge, in this case please replace "S" at the end with "E".

** 10-25A Cam Switches can be supplied with big frame (64 x 64) with extra charge, In this case please replace the "S" at the end with "B".

*** Please replace "S" letter at the end of the code with "SAQ" for Key Operated & Quick Installation With Plate Model (with extra charge)

**** Please replace "S" letter at the end of the code with "K" for Lockable Handle model (with extra charge)

***** Please replace "S" letter at the end of the code with "SQ" for Quick Installation model (with extra charge)

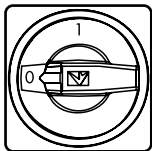

PSA020AK141E

"0-1" Safety On-Off Cam Switches - 90°

Code	Poles	Rated Thermal Current (A)	Enclosure	Key Operated	Quick Installation	Key Operated & Quick Installation With Plate	Lockable Handle With Plate
PSA010AK141E	1 Pole	10	PSK11		✓		✓
PSA016AK141E	1 Pole	16	PSK11		✓		✓
PSA020AK141E	1 Pole	20	PSK11		✓		✓
PSA025AK141E	1 Pole	25	PSK11		✓		✓
PSA032AK141E	1 Pole	32	PSK21				
PSA040AK141E	1 Pole	40	PSK21				
PSA050AK141E	1 Pole	50	PSK31				
PSA063AK141E	1 Pole	63	PSK31				
PSA080AK141E	1 Pole	80	-				
PSA120AK141E	1 Pole	120	-				

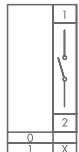

PSA020AK241E

PSA010AK241E	2 Poles	10	PSK11		✓		✓
PSA016AK241E	2 Poles	16	PSK11		✓		✓
PSA020AK241E	2 Poles	20	PSK11		✓		✓
PSA025AK241E	2 Poles	25	PSK11		✓		✓
PSA032AK241E	2 Poles	32	PSK21				
PSA040AK241E	2 Poles	40	PSK21				
PSA050AK241E	2 Poles	50	PSK31				
PSA063AK241E	2 Poles	63	PSK31				
PSA080AK241E	2 Poles	80	-				
PSA120AK241E	2 Poles	120	-				

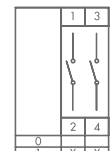

PSA020AK341E

PSA010AK341E	3 Poles	10	PSK11		✓		✓
PSA016AK341E	3 Poles	16	PSK11		✓		✓
PSA020AK341E	3 Poles	20	PSK11		✓		✓
PSA025AK341E	3 Poles	25	PSK11		✓		✓
PSA032AK341E	3 Poles	32	PSK21				
PSA040AK341E	3 Poles	40	PSK21				
PSA050AK341E	3 Poles	50	PSK31				
PSA063AK341E	3 Poles	63	PSK31				
PSA080AK341E	3 Poles	80	-				
PSA120AK341E	3 Poles	120	-				

* 10-25A Cam Switches can be supplied with big frame (64 x 64) with extra charge, In this case please replace the "F" at the end with "E".

** Please replace "E" letter at the end of the code with "EQ" for Quick Installation model (with extra charge)

Rotary Cam Switches

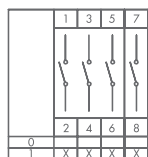

PSA020AK441E

"0-1" Safety On-Off Cam Switches - 90°

Code	Poles	Rated Thermal Current (A)	Enclosure	Key Operated	Quick Installation	Key Operated & Quick Installation With Plate	Lockable Handle With Plate
PSA010AK441E	4 Poles	10	PSK11		✓		✓
PSA016AK441E	4 Poles	16	PSK11		✓		✓
PSA020AK441E	4 Poles	20	PSK11		✓		✓
PSA025AK441E	4 Poles	25	PSK11		✓		✓
PSA032AK441E	4 Poles	32	PSK21				
PSA040AK441E	4 Poles	40	PSK21				
PSA050AK441E	4 Poles	50	PSK31				
PSA063AK441E	4 Poles	63	PSK31				
PSA080AK441E	4 Poles	80	-				
PSA120AK441E	4 Poles	120	-				

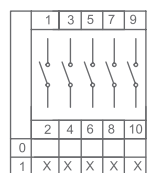

PSA010AK541E	5 Poles	10	PSK12		✓		✓
PSA016AK541E	5 Poles	16	PSK12		✓		✓
PSA020AK541E	5 Poles	20	PSK12		✓		✓
PSA025AK541E	5 Poles	25	PSK12		✓		✓
PSA032AK541E	5 Poles	32	PSK22				
PSA040AK541E	5 Poles	40	PSK22				
PSA050AK541E	5 Poles	50					
PSA063AK541E	5 Poles	63					
PSA080AK541E	5 Poles	80					
PSA120AK541E	5 Poles	120					

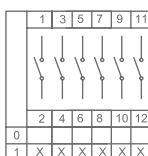

PSA010AK641E	6 Poles	10	PSK12		✓		✓
PSA016AK641E	6 Poles	16	PSK12		✓		✓
PSA020AK641E	6 Poles	20	PSK12		✓		✓
PSA025AK641E	6 Poles	25	PSK12		✓		✓
PSA032AK641E	6 Poles	32	PSK22				
PSA040AK641E	6 Poles	40	PSK22				
PSA050AK641E	6 Poles	50					
PSA063AK641E	6 Poles	63					
PSA080AK641E	6 Poles	80					
PSA120AK641E	6 Poles	120					

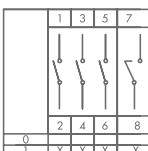

PSA020AK941E

PSA010AK941E	3 Poles+Neutral	10	PSK11		✓		✓
PSA016AK941E	3 Poles+Neutral	16	PSK11		✓		✓
PSA020AK941E	3 Poles+Neutral	20	PSK11		✓		✓
PSA025AK941E	3 Poles+Neutral	25	PSK11		✓		✓
PSA032AK941E	3 Poles+Neutral	32	PSK21				
PSA040AK941E	3 Poles+Neutral	40	PSK21				
PSA050AK941E	3 Poles+Neutral	50	PSK31				
PSA063AK941E	3 Poles+Neutral	63	PSK31				
PSA080AK941E	3 Poles+Neutral	80	-				
PSA120AK941E	3 Poles+Neutral	120	-				

-10-25A Cam Switches can be supplied with big frame (64 x 64) with extra charge, in this case please replace the "E" at the end with "F"
 -Please replace "E" letter at the end of the code with "EQ" for Quick Installation model (with extra charge)

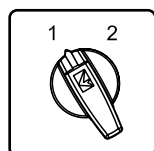

1-2 Changeover Cam Switches - 60°

Code	Poles	Rated Thermal Current (A)	Enclosure	Key Operated	Quick Installation	Key Operated & Quick Installation With Plate	Lockable Handle With Plate
PSA010KD133S	1 Pole	10	PSK11	✓	✓	✓	✓
PSA016KD133S	1 Pole	16	PSK11	✓	✓	✓	✓
PSA020KD133S	1 Pole	20	PSK11	✓	✓	✓	✓
PSA025KD133S	1 Pole	25	PSK11	✓	✓	✓	✓
PSA032KD133S	1 Pole	32	PSK21				
PSA040KD133S	1 Pole	40	PSK21				
PSA050KD133S	1 Pole	50	PSK31				
PSA063KD133S	1 Pole	63	PSK31				
PSA080KD133S	1 Pole	80	-				
PSA120KD133S	1 Pole	120	-				

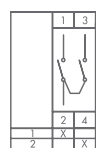

PSA020KD133S

* Can be supplied with Red-Yellow head w/o extra charge, in this case please replace "S" at the end with "E".

** 10-25A Cam Switches can be supplied with big frame (64 x 64) with extra charge, In this case please replace the "S" at the end with "B"

***Please replace "S" letter at the end of the code with "SAQ" for Key Operated & Quick Installation With Plate Model (with extra charge)

**** Please replace "S" letter at the end of the code with "K" for Lockable Handle model (with extra charge)

***** Please replace "S" letter at the end of the code with "SQ" for Quick Installation model (with extra charge)

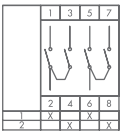

"1-2" Changeover Cam Switches - 60°

Code	Poles	Rated Thermal Current (A)	Enclosure	Key Operated	Quick Installation	Key Operated & Quick Installation With Plate	Lockable Handle With Plate
PSA010KD233S	2 Poles	10	PSK11	✓	✓	✓	✓
PSA016KD233S	2 Poles	16	PSK11	✓	✓	✓	✓
PSA020KD233S	2 Poles	20	PSK11	✓	✓	✓	✓
PSA025KD233S	2 Poles	25	PSK11	✓	✓	✓	✓
PSA032KD233S	2 Poles	32	PSK31				
PSA040KD233S	2 Poles	40	PSK31				
PSA050KD233S	2 Poles	50	-				
PSA063KD233S	2 Poles	63	-				
PSA080KD233S	2 Poles	80	-				
PSA120KD233S	2 Poles	120	-				

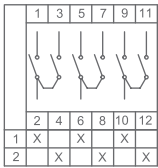

PSA020KD333S

PSA010KD333S	3 Poles	10	PSK12	✓	✓	✓	✓
PSA016KD333S	3 Poles	16	PSK12	✓	✓	✓	✓
PSA020KD333S	3 Poles	20	PSK12	✓	✓	✓	✓
PSA025KD333S	3 Poles	25	PSK12	✓	✓	✓	✓
PSA032KD333S	3 Poles	32	PSK31				
PSA040KD333S	3 Poles	40	PSK31				
PSA050KD333S	3 Poles	50	-				
PSA063KD333S	3 Poles	63	-				
PSA080KD333S	3 Poles	80	-				
PSA120KD333S	3 Poles	120	-				

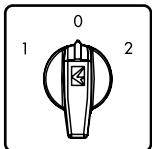

"1-0-2" Changeover Cam Switches - 60°

Code	Poles	Rated Thermal Current (A)	Enclosure	Key Operated	Quick Installation	Key Operated & Quick Installation With Plate	Lockable Handle With Plate
PSA010KD134S	1 Pole	10	PSK11	✓	✓	✓	✓
PSA016KD134S	1 Pole	16	PSK11	✓	✓	✓	✓
PSA020KD134S	1 Pole	20	PSK11	✓	✓	✓	✓
PSA025KD134S	1 Pole	25	PSK11	✓	✓	✓	✓
PSA032KD134S	1 Pole	32	PSK21				
PSA040KD134S	1 Pole	40	PSK21				
PSA050KD134S	1 Pole	50	PSK31				
PSA063KD134S	1 Pole	63	PSK31				
PSA080KD134S	1 Pole	80	-				
PSA120KD134S	1 Pole	120	-				

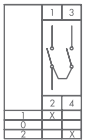

PSA020KD134S

PSA010KD234S	2 Poles	10	PSK11	✓	✓	✓	✓
PSA016KD234S	2 Poles	16	PSK11	✓	✓	✓	✓
PSA020KD234S	2 Poles	20	PSK11	✓	✓	✓	✓
PSA025KD234S	2 Poles	25	PSK11	✓	✓	✓	✓
PSA032KD234S	2 Poles	32	PSK21				
PSA040KD234S	2 Poles	40	PSK21				
PSA050KD234S	2 Poles	50	PSK31				
PSA063KD234S	2 Poles	63	PSK31				
PSA080KD234S	2 Poles	80	-				
PSA120KD234S	2 Poles	120	-				

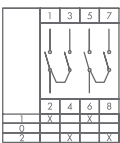

PSA020KD234S

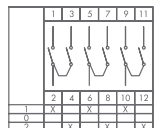

PSA020KD334S

PSA010KD334S	3 Poles	10	PSK12	✓	✓	✓	✓
PSA016KD334S	3 Poles	16	PSK12	✓	✓	✓	✓
PSA020KD334S	3 Poles	20	PSK12	✓	✓	✓	✓
PSA025KD334S	3 Poles	25	PSK12	✓	✓	✓	✓
PSA032KD334S	3 Poles	32	PSK22				
PSA040KD334S	3 Poles	40	PSK22				
PSA050KD334S	3 Poles	50	-				
PSA063KD334S	3 Poles	63	-				
PSA080KD334S	3 Poles	80	-				
PSA120KD334S	3 Poles	120	-				

* Can be supplied with Red-Yellow head w/o extra charge, in this case please replace "S" at the end with "E".

** 10-25A Cam Switches can be supplied with big frame (64 x 64) with extra charge, in this case please replace the "S" at the end with "B".

*** Please replace "S" letter at the end of the code with "SAQ" for Key Operated & Quick Installation With Plate Model (with extra charge)

**** Please replace "S" letter at the end of the code with "K" for Lockable Handle model (with extra charge)

***** Please replace "S" letter at the end of the code with "SQ" for Quick Installation model (with extra charge)



PSA020KD434S

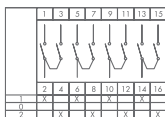

Code	Poles	Rated Thermal Current (A)	Enclosure	Key Operated	Quick Installation	Key Operated & Quick Installation With Plate	Lockable Handle With Plate
PSA010KD434S	4 Poles	10	PSK12	✓	✓	✓	✓
PSA016KD434S	4 Poles	16	PSK12	✓	✓	✓	✓
PSA020KD434S	4 Poles	20	PSK12	✓	✓	✓	✓
PSA025KD434S	4 Poles	25	PSK12	✓	✓	✓	✓
PSA032KD434S	4 Poles	32	PSK22				
PSA040KD434S	4 Poles	40	PSK22				
PSA050KD434S	4 Poles	50					
PSA063KD434S	4 Poles	63					
PSA080KD434S	4 Poles	80	-				
PSA120KD434S	4 Poles	120	-				

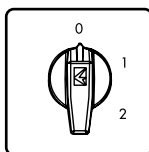

Step Cam Switches - 1 Pole

Code	Poles	Rated Thermal Current (A)	Enclosure	Key Operated	Quick Installation	Key Operated & Quick Installation With Plate	Lockable Handle With Plate
PSA010K*132S	0-1-2	10	PSK11	✓	✓	✓	✓
PSA016K*132S	0-1-2	16	PSK11	✓	✓	✓	✓
PSA020K*132S	0-1-2	20	PSK11	✓	✓	✓	✓
PSA025K*132S	0-1-2	25	PSK11	✓	✓	✓	✓
PSA032K*132S	0-1-2	32	PSK21				
PSA040K*132S	0-1-2	40	PSK21				
PSA050K*132S	0-1-2	50	PSK31				
PSA063K*132S	0-1-2	63	PSK31				
PSA080K*132S	0-1-2	80	-				
PSA120K*132S	0-1-2	120	-				

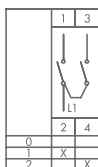

PSA020KS132S

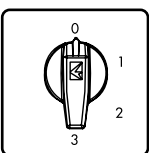

PSA010K*133S	0-3	10	PSK11	✓	✓	✓	✓
PSA016K*133S	0-3	16	PSK11	✓	✓	✓	✓
PSA020K*133S	0-3	20	PSK11	✓	✓	✓	✓
PSA025K*133S	0-3	25	PSK11	✓	✓	✓	✓
PSA032K*133S	0-3	32	PSK21				
PSA040K*133S	0-3	40	PSK21				
PSA050K*133S	0-3	50	PSK31				
PSA063K*133S	0-3	63	PSK32				
PSA080K*133S	0-3	80	-				
PSA120K*133S	0-3	120	-				

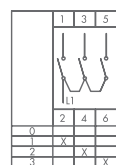

PSA020KS133S

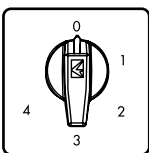

PSA010K*134S	0-4	10	PSK12	✓	✓	✓	✓
PSA016K*134S	0-4	16	PSK12	✓	✓	✓	✓
PSA020K*134S	0-4	20	PSK12	✓	✓	✓	✓
PSA025K*134S	0-4	25	PSK12	✓	✓	✓	✓
PSA032K*134S	0-4	32	PSK22				
PSA040K*134S	0-4	40	PSK22				
PSA050K*134S	0-4	50	PSK32				
PSA063K*134S	0-4	63	PSK32				
PSA080K*134S	0-4	80	-				
PSA120K*134S	0-4	120	-				

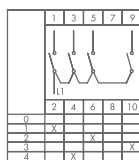

PSA020KS134S

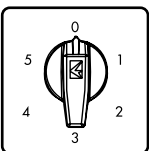

PSA010K*135S	0-5	10	PSK12	✓	✓	✓	✓
PSA016K*135S	0-5	16	PSK12	✓	✓	✓	✓
PSA020K*135S	0-5	20	PSK12	✓	✓	✓	✓
PSA025K*135S	0-5	25	PSK12	✓	✓	✓	✓
PSA032K*135S	0-5	32	PSK22				
PSA040K*135S	0-5	40	PSK22				
PSA050K*135S	0-5	50					
PSA063K*135S	0-5	63					
PSA080K*135S	0-5	80	-				
PSA120K*135S	0-5	120	-				

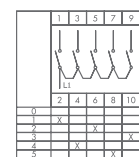

PSA020KS135S

In Rotary cam switches if "0" position required, please replace "*" symbol with "S", if not please replace with "Z".

* Can be supplied with Red-Yellow head w/o extra charge, in this case please replace "S" at the end with "E".

** 10-25A Cam Switches can be supplied with big frame (64 x 64) with extra charge, In this case please replace the "S" at the end with "B".

***Please replace "S" letter at the end of the code with "SAQ" for Key Operated & Quick Installation With Plate Model (with extra charge)

**** Please replace "S" letter at the end of the code with "SQ" for Quick Installation model (with extra charge)

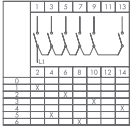
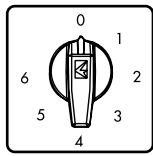

PSA020KS126S

Code	Poles	Rated Thermal Current (A)	Enclosure	Key Operated	Quick Installation	Key Operated & Quick Installation With Plate	Lockable Handle With Plate
PSA010KS126S	0-6	10	PSK12	✓	✓	✓	✓
PSA016KS126S	0-6	16	PSK12	✓	✓	✓	✓
PSA020KS126S	0-6	20	PSK12	✓	✓	✓	✓
PSA025KS126S	0-6	25	PSK12	✓	✓	✓	✓
PSA032KS126S	0-6	32	PSK22				
PSA040KS126S	0-6	40	PSK22				
PSA050KS126S	0-6	50					
PSA063KS126S	0-6	63					
PSA080KS126S	0-6	80	-				
PSA120KS126S	0-6	120	-				

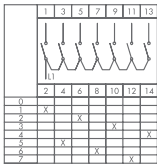
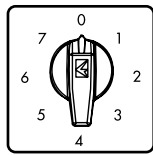

PSA020KS127S

PSA010KS127S	0-7	10	PSK12	✓	✓	✓	✓
PSA016KS127S	0-7	16	PSK12	✓	✓	✓	✓
PSA020KS127S	0-7	20	PSK12	✓	✓	✓	✓
PSA025KS127S	0-7	25	PSK12	✓	✓	✓	✓
PSA032KS127S	0-7	32	PSK22				
PSA040KS127S	0-7	40	PSK22				
PSA050KS127S	0-7	50					
PSA063KS127S	0-7	63					
PSA080KS127S	0-7	80	-				
PSA120KS127S	0-7	120	-				

Step Cam Switches - 60°

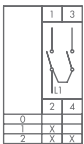
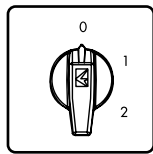

PSA020KT132S

Code	Poles	Rated Thermal Current (A)	Enclosure	Key Operated	Quick Installation	Key Operated & Quick Installation With Plate	Lockable Handle With Plate
PSA010KT132S	1 Pole	10	0-1-2	PSK11	✓	✓	✓
PSA016KT132S	1 Pole	16	0-1-2	PSK11	✓	✓	✓
PSA020KT132S	1 Pole	20	0-1-2	PSK11	✓	✓	✓
PSA025KT132S	1 Pole	25	0-1-2	PSK11	✓	✓	✓
PSA010KT332S	3 Poles	10	0-1-2	PSK12	✓	✓	✓
PSA016KT332S	3 Poles	16	0-1-2	PSK12	✓	✓	✓

Star-Delta Cam Switches - 60°

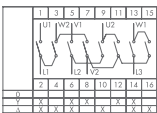
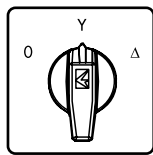

PSA020MS335S

Code	Poles	Rated Thermal Current (A)	Enclosure	Key Operated	Quick Installation	Key Operated & Quick Installation With Plate	Lockable Handle With Plate
PSA010MS335S	3 Phase	10	PSK12	✓	✓	✓	✓
PSA016MS335S	3 Phase	16	PSK12	✓	✓	✓	✓
PSA020MS335S	3 Phase	20	PSK12	✓	✓	✓	✓
PSA025MS335S	3 Phase	25	PSK12	✓	✓	✓	✓
PSA032MS335S	3 Phase	32	PSK22				
PSA040MS335S	3 Phase	40	PSK22				
PSA050MS335S	3 Phase	50					
PSA063MS335S	3 Phase	63					
PSA080MS335S	3 Phase	80	-				
PSA120MS335S	3 Phase	120	-				

* Can be supplied with Red-Yellow head w/o extra charge, in this case please replace "S" at the end with "E".

** 10-25A Cam Switches can be supplied with big frame (64 x 64) with extra charge, In this case please replace the "S" at the end with "B"

***Please replace "S" letter at the end of the code with "SAQ" for Key Operated & Quick Installation With Plate Model (with extra charge)

**** Please replace "S" letter at the end of the code with "SQ" for Quick Installation model (with extra charge)

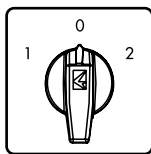

1 Pole Changeover Cam Switches "1-0-2"

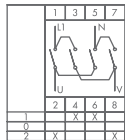

PSA020MS134S

Code	Poles	Rated Thermal Current (A)	Enclosure	Key Operated	Quick Installation	Key Operated & Quick Installation With Plate	Lockable Handle With Plate
PSA010MS134S	1 Phase	10	1-0-2	PSK11	✓	✓	✓
PSA016MS134S	1 Phase	16	1-0-2	PSK11	✓	✓	✓
PSA020MS134S	1 Phase	20	1-0-2	PSK11	✓	✓	✓
PSA025MS134S	1 Phase	25	1-0-2	PSK11	✓	✓	✓
PSA032MS134S	1 Phase	32	1-0-2	PSK21			
PSA040MS134S	1 Phase	40	1-0-2	PSK21			
PSA050MS134S	1 Phase	50	1-0-2	PSK31			
PSA063MS134S	1 Phase	63	1-0-2	PSK31			
PSA080MS134S	1 Phase	80	1-0-2	-			
PSA120MS134S	1 Phase	120	1-0-2	-			

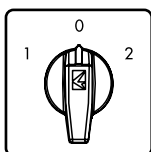

3 Pole Changeover Cam Switches "1-0-2"

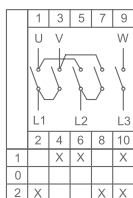

PSA020MS334S

Code	Poles	Rated Thermal Current (A)	Enclosure	Key Operated	Quick Installation	Key Operated & Quick Installation With Plate	Lockable Handle With Plate
PSA010MS334S	3 Phase	10	1-0-2	PSK12	✓	✓	✓
PSA016MS334S	3 Phase	16	1-0-2	PSK12	✓	✓	✓
PSA020MS334S	3 Phase	20	1-0-2	PSK12	✓	✓	✓
PSA025MS334S	3 Phase	25	1-0-2	PSK12	✓	✓	✓
PSA032MS334S	3 Phase	32	1-0-2	PSK22			
PSA040MS334S	3 Phase	40	1-0-2	PSK22			
PSA050MS334S	3 Phase	50	1-0-2	PSK32			
PSA063MS334S	3 Phase	63	1-0-2	PSK32			
PSA080MS334S	3 Phase	80	1-0-2	-			
PSA120MS334S	3 Phase	120	1-0-2	-			

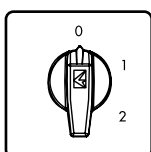

3 Phase Double Cycle Cam Switches (0-1-2)

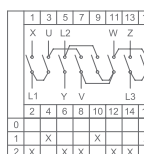

PSA016CD332S

Code	Poles	Rated Thermal Current (A)	Enclosure	Key Operated	Quick Installation	Key Operated & Quick Installation With Plate	Lockable Handle With Plate
PSA010CD332S	3 Phase	10	PSK12	✓	✓	✓	✓
PSA016CD332S	3 Phase	16	PSK12	✓	✓	✓	✓
PSA020CD332S	3 Phase	20	PSK12	✓	✓	✓	✓
PSA025CD332S	3 Phase	25	PSK12	✓	✓	✓	✓
PSA032CD332S	3 Phase	32	PSK22				
PSA040CD332S	3 Phase	40	PSK22				
PSA050CD332S	3 Phase	50					
PSA063CD332S	3 Phase	63					
PSA080CD332S	3 Phase	80	-				
PSA120CD332S	3 Phase	120	-				

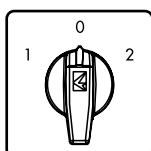

3 Phase Double Cycle Cam Switches (1-0-2)

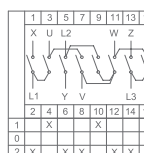

PSA016CD334S

Code	Poles	Rated Thermal Current (A)	Enclosure	Key Operated	Quick Installation	Key Operated & Quick Installation With Plate	Lockable Handle With Plate
PSA010CD334S	3 Phase	10	PSK12	✓	✓	✓	✓
PSA016CD334S	3 Phase	16	PSK12	✓	✓	✓	✓
PSA020CD334S	3 Phase	20	PSK12	✓	✓	✓	✓
PSA025CD334S	3 Phase	25	PSK12	✓	✓	✓	✓
PSA032CD334S	3 Phase	32	PSK22				
PSA040CD334S	3 Phase	40	PSK22				
PSA050CD334S	3 Phase	50					
PSA063CD334S	3 Phase	63					
PSA080CD334S	3 Phase	80	-				
PSA120CD334S	3 Phase	120	-				

* Can be supplied with Red-Yellow head w/o extra charge, in this case please replace "S" at the end with "E".

** 10-25A Cam Switches can be supplied with big frame (64 x 64) with extra charge, In this case please replace the "S" at the end with "B"

***Please replace "S" letter at the end of the code with "SAQ" for Key Operated & Quick Installation With Plate Model (with extra charge)

**** Please replace "S" letter at the end of the code with "SQ" for Quick Installation model (with extra charge)

Rotary Cam Switches

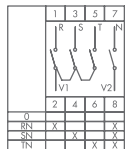
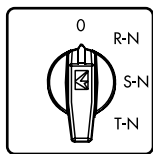

PSA0200K421S

Measuring Cam Switches - 45°

Code	Type	Rated Thermal Current (A)	Position	Enclosure	Key Operated	Quick Installation	Key Operated & Quick Installation With Plate	Lockable Handle With Plate
------	------	---------------------------	----------	-----------	--------------	--------------------	--	----------------------------

PSA0100K421S	4	10	Voltmeter	PSK11	✓	✓	✓	✓
--------------	---	----	-----------	-------	---	---	---	---

PSA0160K421S	4	16	Voltmeter	PSK11	✓	✓	✓	✓
--------------	---	----	-----------	-------	---	---	---	---

PSA0200K421S	4	20	Voltmeter	PSK11	✓	✓	✓	✓
--------------	---	----	-----------	-------	---	---	---	---

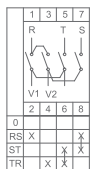
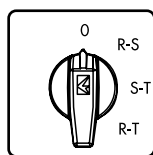

PSA0200K422S

PSA0100K422S	4	10	Phase - Phase Voltmeter	PSK11	✓	✓	✓	✓
--------------	---	----	-------------------------	-------	---	---	---	---

PSA0160K422S	4	16	Phase - Phase Voltmeter	PSK11	✓	✓	✓	✓
--------------	---	----	-------------------------	-------	---	---	---	---

PSA0200K422S	4	20	Phase - Phase Voltmeter	PSK11	✓	✓	✓	✓
--------------	---	----	-------------------------	-------	---	---	---	---

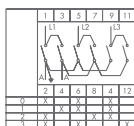
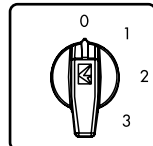

PSA0200K426S

PSA0100K426S	4	10	Ampermeter	PSK12	✓	✓	✓	✓
--------------	---	----	------------	-------	---	---	---	---

PSA0160K426S	4	16	Ampermeter	PSK12	✓	✓	✓	✓
--------------	---	----	------------	-------	---	---	---	---

PSA0200K426S	4	20	Ampermeter	PSK12	✓	✓	✓	✓
--------------	---	----	------------	-------	---	---	---	---

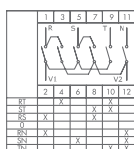
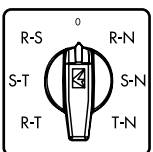

PSA0200K723S

PSA0200K723S	7	20	Voltmeter	PSK12	✓	✓	✓	✓
--------------	---	----	-----------	-------	---	---	---	---

* Please replace "S" letter at the end of the code with "SQ" for Quick Installation model (with extra charge)



PSR1



PSR2



PSMK



PSPK0501



PSK11



PSK12



PSK21



PSK22



PSK31



PSK32

Accessories

Code	Type	Features	Material
PSR1	Rail Mounting Interface	Between 10 - 40 A	Plastic
PSR2	Rail Mounting Interface	Between 50 - 63 A	Plastic
PSMK	Handle Protection Cover	Between 10-25 A	Plastic
PSPK0501	Finger Protection 1 Step	50 A	Plastic
PSPK0502	Finger Protection 2 Step	50 A	Plastic
PSPK0631	Finger Protection 1 Step	63 A	Plastic
PSPK0632	Finger Protection 2 Step	63 A	Plastic

Cam Switch Boxes

Code	Material	Dimensions - Width * Length * Height	Features
PSK11	Plastic	75mm*85mm*65mm	IP54
PSK12	Plastic	75mm*85mm*90mm	IP54
PSK21	Plastic	91mm*100mm*73mm	IP54
PSK22	Plastic	91mm*100mm*103mm	IP54
PSK31	Plastic	106mm*116mm*86mm	IP54
PSK32	Plastic	106mm*116mm*128mm	IP54
PSK11E	Plastic	75mm*85mm*65mm	IP65
PSK12E	Plastic	75mm*85mm*90mm	IP65
PSK21E	Plastic	91mm*100mm*73mm	IP65
PSK22E	Plastic	91mm*100mm*103mm	IP65
PSK31E	Plastic	106mm*116mm*86mm	IP65
PSK32E	Plastic	106mm*116mm*128mm	IP65



PSA020AK131AQ



PSA010KD134SQ



PSA020AK131K



PSA050AK331S + PSPK0502

Standard

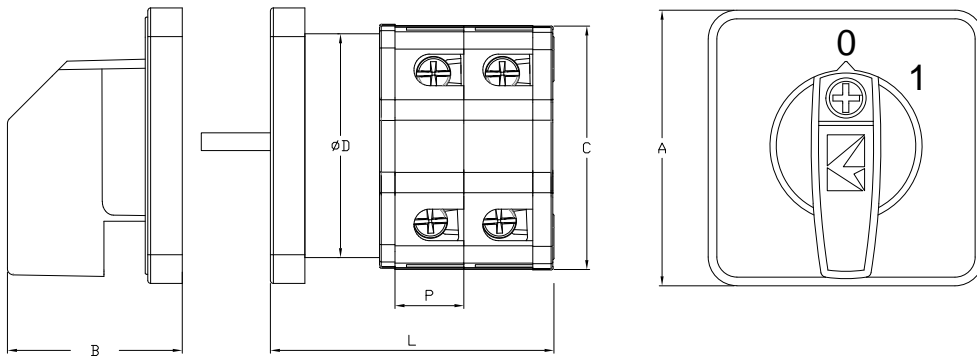

	A	B	C	D
PSA10	48	30,5	42,5	27
PSA16	48	30,5	42,5	27
PSA20	48	30,5	42,5	27
PSA25	48	30,5	42,5	27
PSA32	64	38	55	55
PSA40	64	38	55	55
PSA50	64	38	55	55
PSA63	64	38	55	55
PSA80	85	43	75	75
PSA120	85	43	85	85

Quick Installation

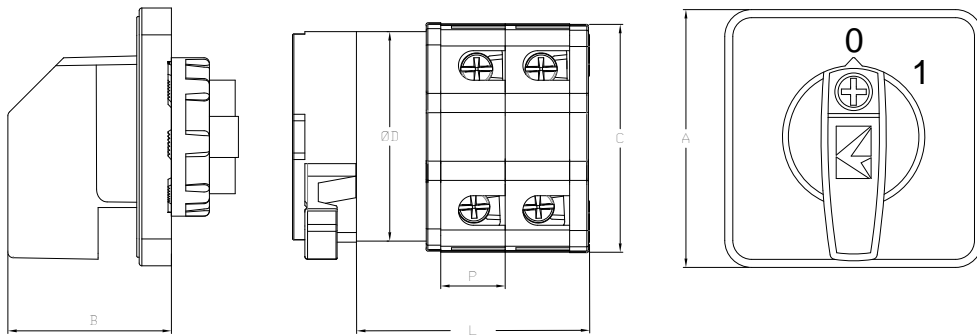

	A	B	C	D
PSA10	48	31	42,5	27
PSA16	48	31	42,5	27
PSA20	48	31	42,5	27
PSA25	48	31	42,5	27
PSA32	64	40	55	55
PSA40	64	40	55	55
PSA50	64	40	55	55
PSA63	64	40	55	55
PSA80	85	45	75	75
PSA120	95	45	85	85

Dimensions

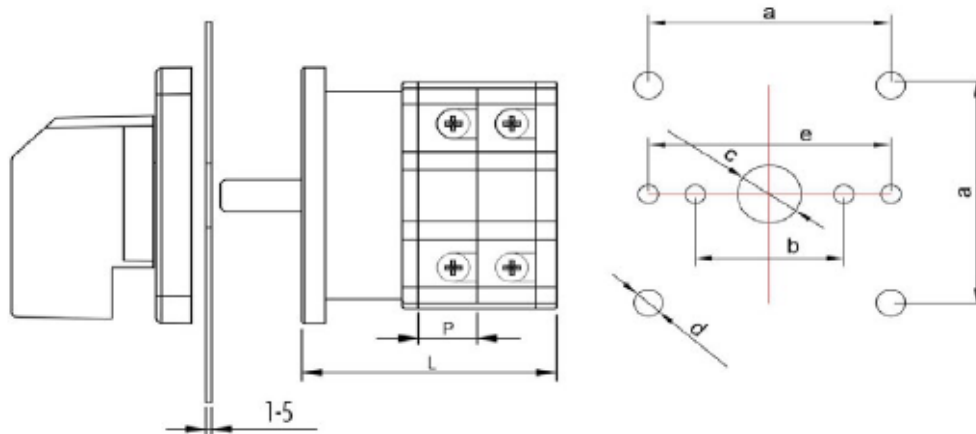

	P	L							
		Poles							
		1	2	3	4	5	6	7	8
PSA10	10	33,2	43,2	53,2	63,2	73,2	83,2	93,2	103,2
PSA16	10	33,2	43,2	53,2	63,2	73,2	83,2	93,2	103,2
PSA20	10	33,2	43,2	53,2	63,2	73,2	83,2	93,2	103,2
PSA25	12	35,2	47,2	59,2	71,2	83,2	95,2	107,2	119,2
PSA32	13	39,2	52,2	65,2	78,2	91,2	104,2	117,2	130,2
PSA40	15	41,2	56,2	71,2	86,2	101,2	116,2	131,2	146,2
PSA50	17,5	43,7	61,2	78,7	96,2	113,7	131,2	148,7	166,2
PSA63	21	47,2	68,2	89,2	110,2	131,2	152,2	173,2	194,2
PSA80	26	63	89	115	141	167	193	219	245
PSA120	30	63	93	123	153	183	213	243	273

	A	B	E	C	D
PSA10	36	30		9,5	4,3
PSA16	36	30		9,5	4,3
PSA20	36	30		9,5	4,3
PSA25	36	30		9,5	4,3
PSA32	48	30	50	10	4,3
PSA40	48	30	50	10	4,3
PSA50	48	30	50	10	4,3
PSA63	48	30	50	10	4,3
PSA80	68	38	50	13	5,2
PSA120	68	38	50	13	5,2

Cam Switches Selection Table



Cam Switches Selection Table

Series	Terminal Type	Amps	Type	Pole	Angle	Label	Option
PS	A	010	AK	1	3	1	S

PS Cam Switches	A Screw B Terminal C Spring Clamp	010 10 Amp 016 16 Amp 020 20 Amp 025 25 Amp 032 32 Amp 040 40 Amp 050 50 Amp 063 63 Amp 080 80 Amp 120 120 Amp 160 160 Amp 200 200 Amp	AK On-Off KD Changeover KS Step KT Multi Step MS Motor Control CD Double Speed Switch OK Measuring switch (Voltmeter-Ampermeter) Z* Special Cam Switch	For AK KT MS CD and KD Switches 1 1 Pole 2 2 Pole 3 3 Pole 4 4 Pole For KS and KT Switches 2 2 Step 3 3 Step 4 4 Step 5 5 Step 6 6 Step 7 7 Step 8 8 Step 9 9 Step For Z Switches <input type="checkbox"/> No	1 30° Angle 2 45° Angle 3 60° Angle 4 90° Angle 5 90° Angle (Spring Return)	S 48X48 Normal E 48x48 Emergency Yellow Red B 64x64 Normal F 64x64 Emergency AQ Key Operated Quick Installation K Lockable Handle G 48x48 Emergency Grey-Black Q Quick Installation 48X48 Normal P Quick Installation 48x48 Emergency Yellow-Red	1 0 1 2 0 1 2 3 1 2 4 1 0 2 Step Switches 2 0 1 2 3 0 1 2 3 4 0 1 2 3 4 5 0 1 2 3 4 5 6 0 1 2 3 4 5 6 7 0 1 2 3 4 5 6 7 8 0 1 2 3 4 5 6 7 8 9 0 1 2 3 4 5 6 7 8 9 Motor Control Switches 4 1 0 2 5 0 Y U Measuring Cam Switches 1 0 R-N S-N T-N 2 0 R-S S-T R-T 6 0 1 2 3 4 R-T S-T R-S 0 R-N S-N T-N Special Rotary Cam Switches <input type="checkbox"/> Special Label
------------------------	--	---	---	---	--	---	--

Example: PSA032AK131B → PSA Series, 32 A, 1 pole, 60 degrees Rotational, 0-1 on-off Cam switch has been selected.