

# CONTROL





# TEMPERATURE CONTROL THERMOSTATS

MODELS	UNIT	PTHT	PTVT
CONTACT FUNCTION	-	NC	NO
TEMPERATURE SETTING RANGE	°C	0-60	0-60
COLOUR OF POTENTIOMETER	-	RED	BLUE
250V AC / 120V AC	A	10 (2)	15 (2)
SENSOR TYPE	-	BIMETAL	
CONTACT TYPE	-	SNAP ACTION	
SERVICE LIFE	Cycle	> 100.000	
ELECTRICAL CONNECTIONS	-	2-POLE TERMINAL	
PLASTIC MATERIAL	-	UL94 V0 ABS FLAME RETARDANT	
PROTECTION DEGREE	EN60529	IP20	
OPERATING TEMPERATURE	°C	-25 / +80	
STORAGE TEMPERATURE	°C	-45 / +80	
MOUNTING	-	CLIP FOR MOUNTING on DIN RAIL 35mm	
INSTALLATION POSITION	-	VARIABLE	
CONFORMITY	-	CE	
DIMENSIONS HxWxD	mm	61x34x38	
WEIGHT	g	45	

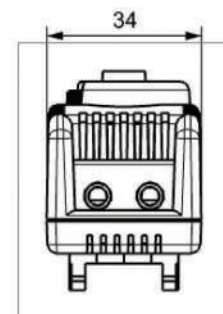
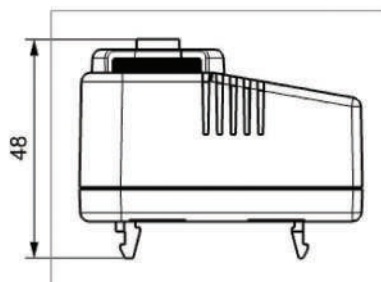
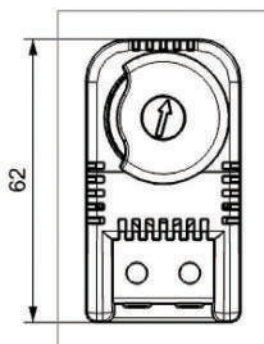



# TEMPERATURE CONTROL DUAL THERMOSTAT

MODELS	UNIT	PTHVT
CONTACT FUNCTION	-	NC+NO
TEMPERATURE SETTING RANGE	°C	0-60 / 0-60
COLOUR OF POTENTIOMETER	-	RED + BLUE
250V AC / 120V AC	A	10 (2) / 15 (2)
SENSOR TYPE	-	BIMETAL
CONTACT TYPE	-	SNAP ACTION
SERVICE LIFE	Cycle	> 100.000
ELECTRICAL CONNECTIONS	-	4-POLE TERMINAL
PLASTIC MATERIAL	-	UL94 V0 ABS FLAME RETARDANT
PROTECTION DEGREE	EN60529	IP20
OPERATING TEMPERATURE	°C	-25 / +80
STORAGE TEMPERATURE	°C	-45 / +80
MOUNTING	-	CLIP FOR MOUNTING on DIN RAIL 35mm
INSTALLATION POSITION	-	VARIABLE
CONFORMITY	-	CE
DIMENSIONS HxWxD	mm	65x59x42
WEIGHT	g	80

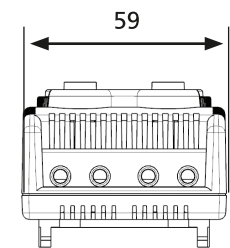
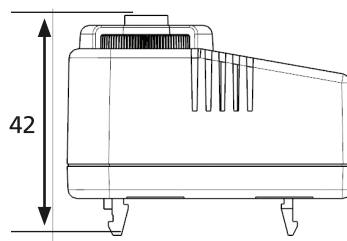
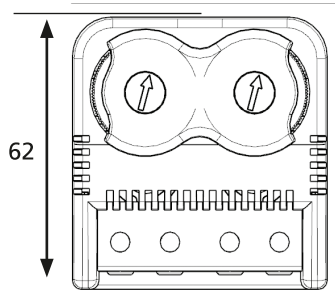



# HUMIDITY CONTROL MECHANICAL HYGROSTAT

MODELS	UNIT	PHG02
POWER SUPPLY	V AC	110-250
SETTING RANGE	%RH	10-90
COLOUR OF POTENTIOMETER	-	BLACK
CURRENT	A	10-5
DIFFERENTIAL	-	%5, max. %10
SENSOR TYPE	-	POLYAMIDE RIBBON
ELECTRICAL CONNECTIONS	-	3-POLE TERMINAL
ELECTRICAL SECTION WIRES	-	FROM 0,75mm <sup>2</sup> to 4.0mm <sup>2</sup>
OPERATING TEMPERATURE	°C	+10 / +60
STORAGE TEMPERATURE	°C	+10 / +60
PROTECTION DEGREE	-	IP20
COLOUR	-	RAL7035
MOUNTING	-	CLIP FOR MOUNTING on DIN RAIL 35mm
DIMENSIONS HxWxD	mm	94x56x54
WEIGHT	g	180
CONFORMITY	-	CE

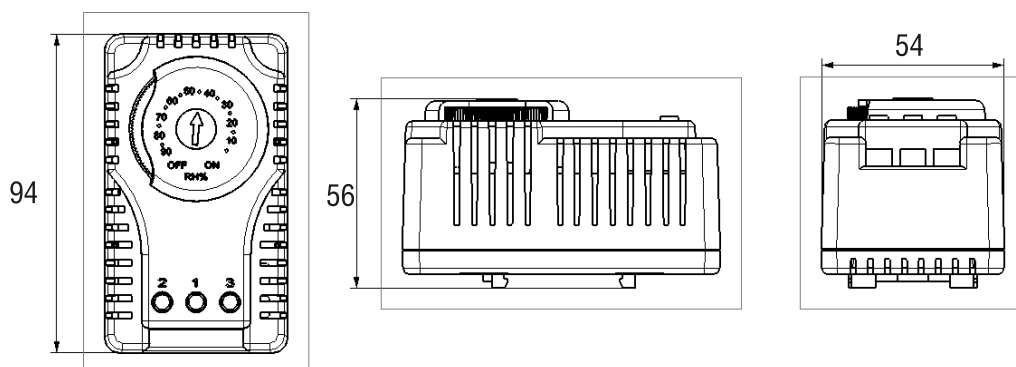

# DIGITAL HYGROTHERM

## Technical Specifications

- Dimensions : 35x77mm
- Display : 3 Digits 7 Segment
- Sensor Type : Digital Temperature/Humidity sensor
- Measuring Scale : -19.9 .. 80.0 °C, 5 .. 95%RH
- Resolution :  $\pm 1$  °C,  $\pm 1$ %RH
- Accuracy (typical) :  $\pm 1$  (°C),  $\pm 3$  (%RH); over full scale
- Control Form : ON-OFF
- °C Out Output : Relay (NO + NC), 250VAC, 2A, Resistive load
- %RH Out Output : Relay (NO), 250VAC, 2A, Resistive load
- °C Function : Ht (heating), CL (cooling);selectable
- %RH Function : lo (decrease humidity), hi (increase humidity);selectable
- Supply Voltage : 100..240VAC, 50 / 60Hz
- Power Consumption : < 6VA
- Operating Temp. : 0 .. 50 °C
- Operating Altitude : H-C; Ht(Heating), CL (Cooling); selectable
- Power Consumption : <6 VA
- Failure : In case of measurement failure, "Err" message displayed and Relay outputs become OFF.

NOTE: The temperature and humidity sensor is included in the device



HT-310

# DIGITAL THERMOSTAT

## Technical Specifications

- Dimensions : 36x90x65mm, rail mount
- Display : 3 Digits 7 Segment
- Sensor Type : PTC
- Measuring Scale : -50...+150 °C
- Resolution :  $\pm 1$  °C
- Accuracy :  $\pm 1$  (Over full scale)
- Control Form : ON-OFF
- Out Output : Relay , 250 VAC, 2A, Resistive Load
- Alarm Output : Relay , 250 VAC, 2A, Resistive Load
- Heat Set : LoL...UPL °C (Hst)
- Alarm Set : AtP=Ab s,-Ab; LoL... °C (Ast)  
AtP=rEL, -rL; (HSt+rAL) ,(HSt-20) ... (Hst+20) °C
- Heat Hysteresis : 1...20 °C (Hhs)
- Alarm Hysteresis : 1...20 °C (Hhs)
- Offset : -20...+20 °C (OFS)
- Function : H-C; Ht(Heating), CL (Cooling); selectable
- Supply Voltage : 100...240 VAC, 50/60 Hz
- Power Consumption : <6 VA
- Operating Temperature: -20 °C...55°C
- Operating Altitude : <2000m  
Failure

NOTE: The PTC Sensor is included in the device.



PDT 50- 150