



Read this document carefully before using this device. The guarantee will be expired by device damages if you don't attend to the directions in the user manual. Also we don't accept any compensations for personal injury, material damage or capital disadvantages.

ENDA EPA542 PROGRAMMABLE AC/DC AMMETER

Thank you for choosing ENDA EPA542 programmable AC/DC ammeter.

- ▶ 54 x 94mm sized.
- ▶ 4 digits display.
- ▶ Easy to use with front panel keypad.
- ▶ 5A or 60 mV , CT20/30 current transformer or 60 mV input feature (Please Specify at Order). ⚠
- ▶ Programmable scale range between 5A and 9999A.
- ▶ Multifunctional alarm output (NO+NC) for upper and lower limits.
- ▶ Communication feature over isolated RS485, using ModBus RTU protocol (Optional).
- ▶ Measuring type can be selected as AC, DC or true RMS.
- ▶ Keylock feature.
- ▶ 0-20mA, 4-20mA, 0-10V or 1-5V output selection (Specified devices with output type 'A' only).
- ▶ CE marked according to European Norms.

⚠ CT20/30 should be ordered separately if required.

Order Code : EPA542 - <input type="text"/> - <input type="text"/> - <input type="text"/> - <input type="text"/>			
1- Supply Voltage UV.....90-250V AC LV.....10-30V DC / 8-24V AC	2 - Input CT.....CT20/30 Current Transformer input OR 60mV. X1.....1A Default (Blank).....5A or 60mV.	3 - Output R.....08A Relay A.....Analog	4 - Isolated Modbus RSI.....RS485 Modbus Available (Specify at order)



TECHNICAL SPECIFICATIONS

ENVIRONMENTAL CONDITIONS							
Ambient/Storage Temperature	0 ... +50°C/-25 ... 70°C						
Max. Relative Humidity	80% Relative humidity for temperatures up to 31°C, decreasing linearly to 50% at 40°C.						
Rated Pollution Degree	According to EN 60529 Front panel : IP65 , Rear panel : IP20						
Height	Max. 2000mm						
⚠ KEEP AWAY device from exposed to corrosive, volatile and flammable gases or liquids and DO NOT USE the device in similar hazardous locations.							
ELECTRICAL CHARACTERISTICS							
Supply	90-250V AC 50/60Hz ;10-30V DC / 8-24V AC SMPS						
Power Consumption	Max. 5VA						
Wiring	2.5mm ² screw-terminal connections						
Scale	<table border="1"> <tr> <td>AC and RMS</td> <td> <p>If input type is 5A / 60mV, scale 0A...9999A : (Specified by <i>c.t.r.r</i> parameter. i.e : scale is 0A...5A for <i>c.t.r.r</i> = 5)</p> <p>If input type is 1A, scale 0A...9999A : (Specified by <i>c.t.r.r</i> parameter. i.e : scale is 0A...1A for <i>c.t.r.r</i> = 1)</p> <p>If input type is CT20/30 / 60mV :</p> <p>If <i>t.y.p</i> = <i>Ct20</i> , 0A...300A or <i>Ct30</i> , 0A...120A (Specified by <i>t.u.r.n</i> parameter. i.e : scale is 0A...300A / 0A...120A for <i>t.u.r.n</i> = 1)</p> <p>If <i>t.y.p</i> = <i>Shnt</i> , 0A...9999A (Specified by <i>c.t.r.r</i> parameter. i.e : scale is 0A...5A for <i>c.t.r.r</i> = 5)</p> </td> </tr> <tr> <td>DC</td> <td> <p>If input type is 5A / 60mV, scale : -999A...9999A (Specified by <i>c.t.r.r</i> parameter. i.e : scale is -5A...5A for <i>c.t.r.r</i> = 5)</p> <p>If input type is 1A, scale : -999A...9999A (Specified by <i>c.t.r.r</i> parameter. i.e : scale is -1A...1A for <i>c.t.r.r</i> = 1)</p> <p>If input type is CT20/30 / 60mV :</p> <p>DC measurement can not be performed by using CT.</p> <p>If <i>t.y.p</i> = <i>Shnt</i> , scale : 0A...9999A (Specified by <i>c.t.r.r</i> parameter. i.e : scale is -5A...5A for <i>c.t.r.r</i>=5)</p> </td> </tr> </table>	AC and RMS	<p>If input type is 5A / 60mV, scale 0A...9999A : (Specified by <i>c.t.r.r</i> parameter. i.e : scale is 0A...5A for <i>c.t.r.r</i> = 5)</p> <p>If input type is 1A, scale 0A...9999A : (Specified by <i>c.t.r.r</i> parameter. i.e : scale is 0A...1A for <i>c.t.r.r</i> = 1)</p> <p>If input type is CT20/30 / 60mV :</p> <p>If <i>t.y.p</i> = <i>Ct20</i> , 0A...300A or <i>Ct30</i> , 0A...120A (Specified by <i>t.u.r.n</i> parameter. i.e : scale is 0A...300A / 0A...120A for <i>t.u.r.n</i> = 1)</p> <p>If <i>t.y.p</i> = <i>Shnt</i> , 0A...9999A (Specified by <i>c.t.r.r</i> parameter. i.e : scale is 0A...5A for <i>c.t.r.r</i> = 5)</p>	DC	<p>If input type is 5A / 60mV, scale : -999A...9999A (Specified by <i>c.t.r.r</i> parameter. i.e : scale is -5A...5A for <i>c.t.r.r</i> = 5)</p> <p>If input type is 1A, scale : -999A...9999A (Specified by <i>c.t.r.r</i> parameter. i.e : scale is -1A...1A for <i>c.t.r.r</i> = 1)</p> <p>If input type is CT20/30 / 60mV :</p> <p>DC measurement can not be performed by using CT.</p> <p>If <i>t.y.p</i> = <i>Shnt</i> , scale : 0A...9999A (Specified by <i>c.t.r.r</i> parameter. i.e : scale is -5A...5A for <i>c.t.r.r</i>=5)</p>		
AC and RMS	<p>If input type is 5A / 60mV, scale 0A...9999A : (Specified by <i>c.t.r.r</i> parameter. i.e : scale is 0A...5A for <i>c.t.r.r</i> = 5)</p> <p>If input type is 1A, scale 0A...9999A : (Specified by <i>c.t.r.r</i> parameter. i.e : scale is 0A...1A for <i>c.t.r.r</i> = 1)</p> <p>If input type is CT20/30 / 60mV :</p> <p>If <i>t.y.p</i> = <i>Ct20</i> , 0A...300A or <i>Ct30</i> , 0A...120A (Specified by <i>t.u.r.n</i> parameter. i.e : scale is 0A...300A / 0A...120A for <i>t.u.r.n</i> = 1)</p> <p>If <i>t.y.p</i> = <i>Shnt</i> , 0A...9999A (Specified by <i>c.t.r.r</i> parameter. i.e : scale is 0A...5A for <i>c.t.r.r</i> = 5)</p>						
DC	<p>If input type is 5A / 60mV, scale : -999A...9999A (Specified by <i>c.t.r.r</i> parameter. i.e : scale is -5A...5A for <i>c.t.r.r</i> = 5)</p> <p>If input type is 1A, scale : -999A...9999A (Specified by <i>c.t.r.r</i> parameter. i.e : scale is -1A...1A for <i>c.t.r.r</i> = 1)</p> <p>If input type is CT20/30 / 60mV :</p> <p>DC measurement can not be performed by using CT.</p> <p>If <i>t.y.p</i> = <i>Shnt</i> , scale : 0A...9999A (Specified by <i>c.t.r.r</i> parameter. i.e : scale is -5A...5A for <i>c.t.r.r</i>=5)</p>						
Sensitivity	0.002A x <i>c.t.r.r</i> (i.e. : 0.01A for <i>c.t.r.r</i> = 5)						
Accuracy	<table border="1"> <tr> <td>AC</td> <td>±%1 (full scale) (± 2% For square wave form)</td> </tr> <tr> <td>DC</td> <td>±%1 (full scale)</td> </tr> <tr> <td>RMS</td> <td>±%1 (full scale) (± 2% For square wave form)</td> </tr> </table>	AC	±%1 (full scale) (± 2% For square wave form)	DC	±%1 (full scale)	RMS	±%1 (full scale) (± 2% For square wave form)
AC	±%1 (full scale) (± 2% For square wave form)						
DC	±%1 (full scale)						
RMS	±%1 (full scale) (± 2% For square wave form)						
Input Range	<table border="1"> <tr> <td>2 and 3</td> <td>-1A...1A (Device may be damaged at 2A and above currents)</td> </tr> <tr> <td>1 and 4</td> <td>-5A...5A or CT20/30 input, 0 ... 150 mA (Device may be damaged at 10A and above currents)</td> </tr> <tr> <td></td> <td>-60mV...60mV (Device may be damaged at 50V and above voltages) ⚠</td> </tr> </table>	2 and 3	-1A...1A (Device may be damaged at 2A and above currents)	1 and 4	-5A...5A or CT20/30 input, 0 ... 150 mA (Device may be damaged at 10A and above currents)		-60mV...60mV (Device may be damaged at 50V and above voltages) ⚠
2 and 3	-1A...1A (Device may be damaged at 2A and above currents)						
1 and 4	-5A...5A or CT20/30 input, 0 ... 150 mA (Device may be damaged at 10A and above currents)						
	-60mV...60mV (Device may be damaged at 50V and above voltages) ⚠						
Input Impedance	<table border="1"> <tr> <td>2 and 3</td> <td>12mΩ (For 5A input) , 90mΩ (For 1A input)</td> </tr> <tr> <td>1 and 4</td> <td>40kΩ (For 5A input) , 600mΩ (For CT20/30 input)</td> </tr> </table>	2 and 3	12mΩ (For 5A input) , 90mΩ (For 1A input)	1 and 4	40kΩ (For 5A input) , 600mΩ (For CT20/30 input)		
2 and 3	12mΩ (For 5A input) , 90mΩ (For 1A input)						
1 and 4	40kΩ (For 5A input) , 600mΩ (For CT20/30 input)						
Frequency Range	DC , 10Hz - 200Hz (10Hz - 70Hz For square wave form)						
EMC	EN 61326-1: 2013						
Safety Requirements	EN 61010-1: 2010 (Pollution degree 2, overvoltage category II)						
OUTPUTS							
Analog Output	0-20mA DC, 4-20mA DC, 0-10V DC or 1-5V DC can be selected on program. (Load resistance for current outputs Max. 500Ω).						
Output	Relay : 250V AC, 8A (for resistive load), NO+NC						
Life Expectancy For Relay	Mechanical 30.000.000; Electrical 100.000 operation. 250V AC, 8A (resistive load).						
HOUSING							
Housing Type	Suitable for EN60715 Standards, TH35 rail type.						
Dimensions	W54xH94xD68mm						
Weight	Approx. 250g (after packing)						
Enclosure Material	Self extinguishing plastics.						
⚠ Avoid any liquid contact when the device is switched on. DO NOT clean the device with solvent (thinner, gasoline, acid etc.) and / or abrasive cleaning agents.							

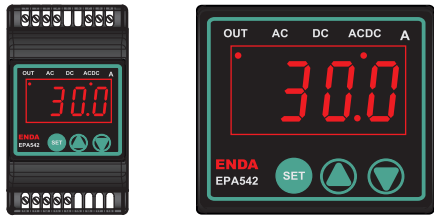

EPA542 PROGRAMMING DIAGRAM

- Increment key** Used for increasing the setpoint value and changing parameters. When held down for a few seconds, configured numeric value increases faster.
- Decrement key** Used for decreasing the setpoint value and changing parameters. When held down for a few seconds, configured numeric value decreases faster.
- Programming key** Used for displaying and configuring the selected parameter value.

If these keys are pressed and held for 3 seconds, "Programming Mode" is entered or it returns to "Running Mode". If and keys are pressed respectively while parameter names are displayed, than it returns to measured value.

PROGRAMMING MODE

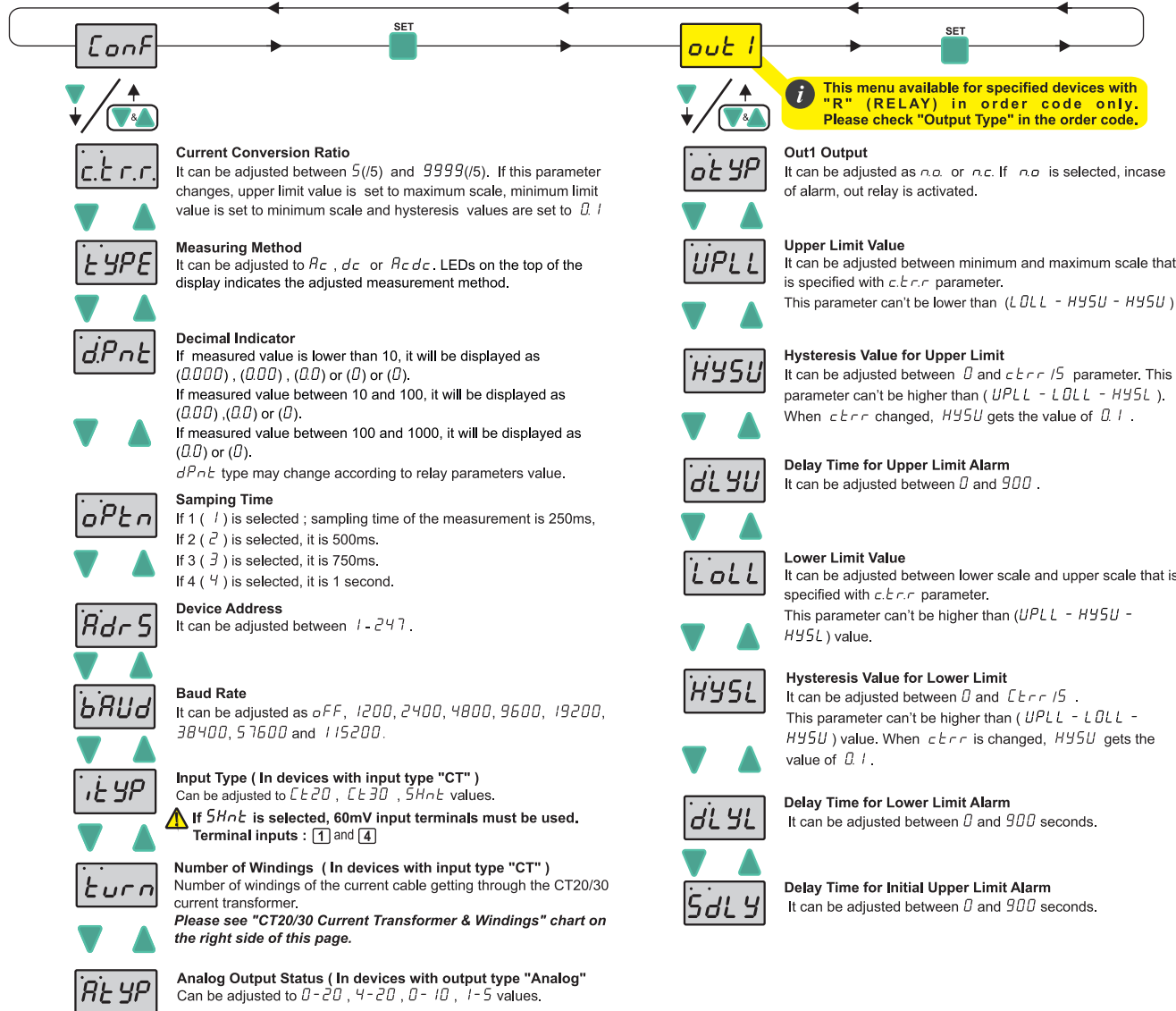

LOCKING & UNLOCKING KEYPAD

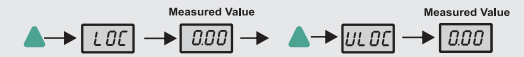

In "Running Mode", by pressing to key for 3 seconds, keypad locked or unlocked.

QUICK MENU



By pressing to key for 3 seconds, quick menu is entered.

REVISION NUMBER



If these keys are pressed and held together, revision date appears as day, month and year. While revision information displayed and if one of the pressed key is released, measured value is displayed again.

SETTING UP THE PARAMETERS

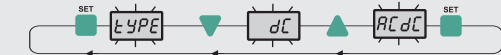

- If key is pressed, the current value of the parameter appears by flashing on the display.
- By using "UP" or "DOWN" navigation keys, selected parameter can be adjusted to the desired value.
- After the setting up the parameters, if set key is pressed again, adjusted parameter name appears on display.

DEFAULT SETTINGS



Powered on device by pressing key. *dPAr* message appears on display and device resets to default settings.

ERROR MESSAGES



Measured current value is higher than maximum scale.



Measured current value is lower than minimum scale.

CT20/30 Current Transformer & Windings Chart

	turn	1	2	3	4	5	6	7	8	9	10
CT20	I _m max(A)	300	150	100	75	60	50	42,8	37,5	33,3	30
CT30	I _m max(A)	120	60	40	30	24	20	17,1	15	13,3	12

Note :

If *ityp* = *shnt*, *turn* parameter is not appears.
If *ityp* = *ct20* or *ct30*, *ctrr* parameter is not appears.

Note :

Before setting the relay parameters, the operating scale must be determined from *dpnt* parameter.
If *dpnt*, *type* and *ityp* parameters are changed (if applicable), *upll*, *loll*, *hysu* and *hysl* values must be checked.

DIMENSIONS & CONNECTION DIAGRAM

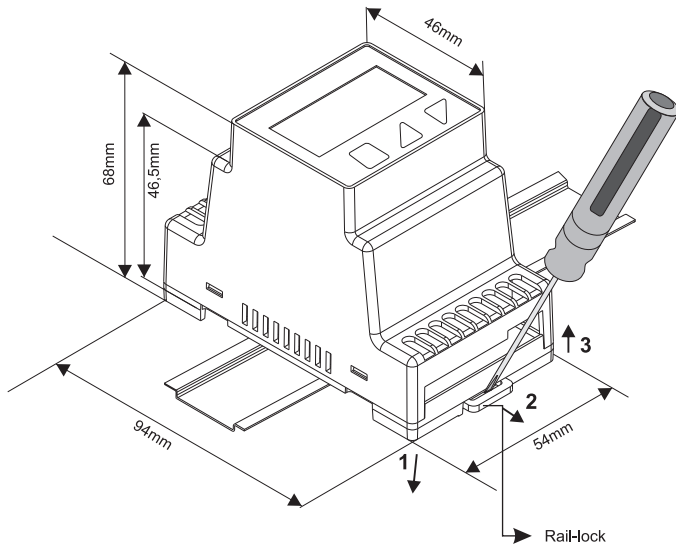

For mounting the device on rail :
Push the device to rail in direction 1 and make sure that rail-lock is interlocked to rail.

For removing the device from rail :
Push the rail-lock with a flat tip screwdriver in direction 2 and pull the device in direction 3.



Equipment is protected throughout by **DOUBLE INSULATION**



Holding screw 0.4-0.5Nm.



ENDA EPA542 ammeters are rail mounted control devices. Device must be used according to instructions. Mounting and electrical connections must be carried out by a qualified staff and must be according to the relevant locally applicable regulations. During an installation, all of the cables that are connected to the device must be free of electrical power. The device must be protected against inadmissible humidity, vibrations and severe soiling. Make sure that the operation temperature is not exceeded. The cables should not be close to the power cables or components.



CAUTION :
If 5A / CT20-30 and 60mV inputs are connected at the same time, the measurement will be incorrect.

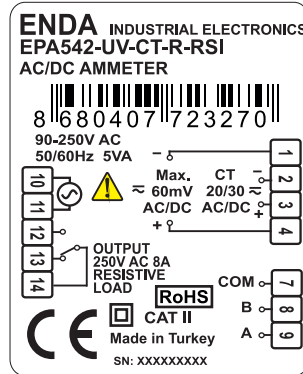
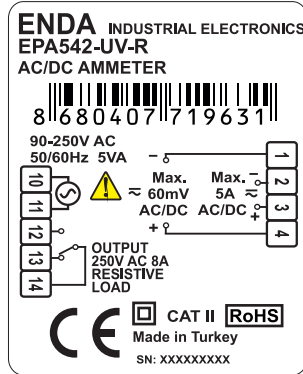
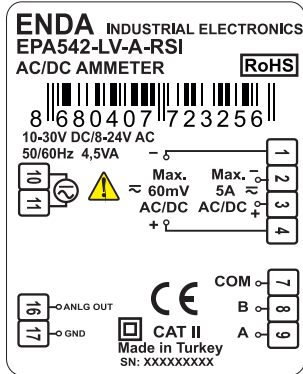

CT20
Measurement Input
0-300A

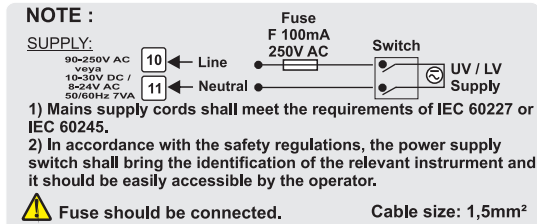

Please see page 5 for Modbus Connection Diagram

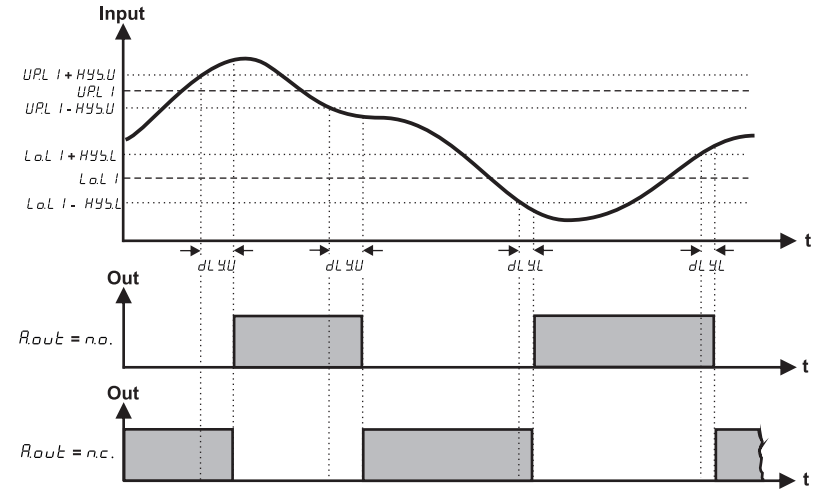

	R_c	dc	$R_c \cdot dc$ (rms)
	$A \frac{1}{\sqrt{2}}$	0.000	$A \frac{1}{\sqrt{2}}$
	0.308 A	$A \frac{2}{\pi}$	$A \frac{1}{\sqrt{2}}$
	0.386 A	$A \frac{1}{\pi}$	$A \frac{1}{2}$
	A	0.000	A
	$A \frac{1}{2}$	$A \frac{1}{2}$	$A \frac{1}{\sqrt{2}}$
	$A \sqrt{\frac{d}{T} - \frac{d^2}{T^2}}$	$A \frac{d}{T}$	$A \sqrt{\frac{d}{T}}$
	$A \frac{1}{\sqrt{3}}$	0.000	$A \frac{1}{\sqrt{3}}$

ENDA EPA542 DIGITAL AMMETER MODBUS PROTOCOL ADDRESS MAP

HOLDING REGISTERS FOR OUTPUT TYPE UNIT "R" (RELAY) DEVICES

Holding Register Adresleri		Data Type	Data Content	Parameter Name	Read/Write Permission	Default Value
Decimal	Hex					
0000d	0x0000	word	Alarm output status	<i>DEYP</i>	R / W	<i>no</i>
0001d	0x0001	word	Current replacement rate	<i>ctrr</i>	R / W	<i>5</i>
0002d	0x0002	word	The upper limit of the setpoint	<i>UPLL</i>	R / W	<i>5.00</i>
0003d	0x0003	word	The upper limit of the hysteresis value	<i>HYSU</i>	R / W	<i>0.10</i>
0004d	0x0004	word	Delay time for the upper limit alarm	<i>dLYU</i>	R / W	<i>0</i>
0005d	0x0005	word	The lower limit of the setpoint	<i>LOLL</i>	R / W	<i>0.00</i>
0006d	0x0006	word	The lower limit of the hysteresis value	<i>HYSL</i>	R / W	<i>0.10</i>
0007d	0x0007	word	Delay time for the lower limit alarm	<i>dLYL</i>	R / W	<i>0</i>
0008d	0x0008	word	Measurement method (0=AC, 1=dC, 2=ACdC)	<i>TYPE</i>	R / W	<i>ACdC</i>
0009d	0x0009	word	Decimal point. (0 = 0 , 1 = 0.0 , 2 = 0.00 , 3 = 0.000)	<i>dPnt</i>	R / W	<i>0.00</i>
0010d	0x000A	word	Sampling time of the measurement value. If 1 is selected, it is 250ms. If 2 is selected, it is 500ms. If 3 is selected, it is 750ms. If 4 is selected, it is 1 second.	<i>OPtn</i>	R / W	<i>4</i>
0011d	0x000B	word	Device address for RS485 network connection. Adjustable between 1-247.	<i>AdrS</i>	R / W	<i>1</i>
0012d	0x000C	word	Baudrate (0=Off;1=1200;2=2400; 3=4800; 4=9600; 5=19200 6= 38400; 7= 57600; 8= 115200)	<i>BRUD</i>	R / W	<i>OFF</i>
0013d	0x000D	word	Delay Time for Initial Upper Limit Alarm	<i>SDLY</i>	R / W	<i>0</i>
*0014d	0x000E	word	Input Type (0 = <i>CT20</i> , 1 = <i>CT30</i> , 2 = <i>SHnt</i>)	<i>ITYP</i>	R / W	<i>CT20</i>
*0015d	0x000F	word	Number of windings for transformer	<i>TURN</i>	R / W	<i>1</i>

⚠ * 14d and 15d addresses are available for only in CT20/30 input type devices.

HOLDING REGISTERS FOR OUTPUT TYPE UNIT "BLANK" (NO RELAY) OR "A" (ANALOG) DEVICES

0000d	0x0000	word	Current Conversion Ratio	<i>ctrr</i>	R / W	<i>5</i>
0001d	0x0001	word	Measurement method (0=AC, 1=dC, 2=ACdC)	<i>TYPE</i>	R / W	<i>ACdC</i>
0002d	0x0002	word	Decimal point (0 = 0 , 1 = 0.0 , 2 = 0.00 , 3 = 0.000)	<i>dPnt</i>	R / W	<i>0.00</i>
0003d	0x0003	word	Sampling time of the measurement value	<i>OPtn</i>	R / W	<i>4</i>
0004d	0x0004	word	Device address for RS485 network connection. Adjustable between 1-247.	<i>AdrS</i>	R / W	<i>1</i>
0005d	0x0005	word	Baudrate (0=Off;1=1200;2=2400; 3=4800; 4=9600; 5=19200 6= 38400; 7= 57600; 8= 115200)	<i>BRUD</i>	R / W	<i>OFF</i>
*0006d	0x0006	word	Input Type (0 = <i>CT20</i> , 1 = <i>CT30</i> , 2 = <i>SHnt</i>)	<i>ITYP</i>	R / W	<i>CT20</i>
*0007d	0x0007	word	Number of windings for transformer	<i>TURN</i>	R / W	<i>1</i>
**0008d	0x0008	word	Analog output type. (0 = 0 - 20 , 1 = 4 - 20 , 2 = 0 - 10 , 3 = 1 - 5)	<i>ATYPE</i>	R / W	<i>0-20</i>

⚠ * 6d and 7d addresses are available for only in CT20/30 input type devices.

⚠ ** Address 8d is available for only in "A" (Analog) input type devices.

⚠ **NOTE :**

In devices with input type CT20/30, following parameter settings will change automatically if the *ITYP* parameter is changed.

If *ITYP* = *CT20* ; *UPLL* = 300.0 , *LOLL* = 0 , *HYSU* = 0.10 , *HYSL* = 0.10

If *ITYP* = *CT30* ; *UPLL* = 120.0 , *LOLL* = 0 , *HYSU* = 0.10 , *HYSL* = 0.10

ENDA EPA542-xx-xx-x-RSI INPUT REGISTERS FOR OUTPUT DEVICES

Input Register Addresses		Data Type	Data Content	Parameter Name	Read / Write Permission
Decimal	Hex				
0000d	0x0000	word	Measured current value	--	Read Only
0001d	0x0001	word	Decimal point of measured current value	--	Read Only
0002d	0x0002	word	Specified analog output value	--	Read Only

ENDA EPA542-xx-xx-R-RSI DIGITAL AMMETER WITH ALARM RELAY OUTPUT DISCRETE INPUTS

Discrete Input Addresses		Data Type	Data Content	Parameter Name	Read/Write Permission
Decimal	Hex				
00d	0x00	Bit	Relay output state (0=OFF; 1=ON)	--	Read Only

ENDA EPA542-xx-xx-R-RSI DIGITAL AMMETER WITH ALARM RELAY OUTPUT COILS INPUTS

Coil Addresses		Data Type	Data Content	Parameter Name	Read/Write Permission	Default Value
Decimal	Hex					
00d	0x00	Bit	Output state (0=NO; 1=NC)	OLYP	R / W	NO

- Note 1** : Coil and Discrete input parameters are not available in the devices those have no relay
- Note 2** : OLYP menu parameters can be used as "Holding Register" or "Coil."
- Note 3** : Value read in 0th address of input register gives the measured value. Also, the 1st address of the input register specifies the decimal part of the measured current value.
For example ;
Value read in 0th address of input register is 2842 , if value read in 1st address from input register as 1, it is 284.2
Value read in 0th address of input register is 2842 , if value read in 1st address from input register as 2, it is 28.42
Value read in 0th address of input register is 2842 , if value read in 1st address from input register as 3, it is 2.842

* MODBUS CONNECTION DIAGRAM

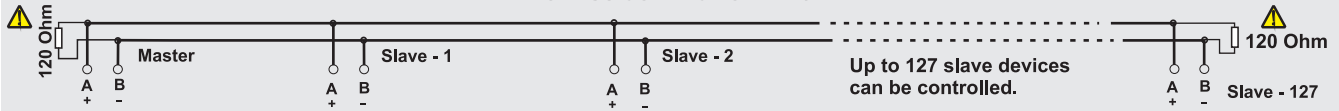

! Termination should be accomplished by attaching 120 Ohm resistors to the start and at the end of the communication line.

* Applies to devices with Modbus function.