

ENDA ETS Series Rail and Panel Mounted Heat Sinks

Thank you for choosing ENDA products.

ETS series rail and panel mounted heat sinks are designed for EPxA1 and EPxA3 series Panel Mounted Solid State Relays.



ORDER CODE

ETS-62-100F

Product Basic Code		Fan	
Heat-sink	ETS	Fan	F
Width		Depth	
46mm	46	62mm	62
62mm	62	80mm	80
99mm	99	100mm	100

ENDA ETS-46-100 RAIL MOUNTED HEAT SINK

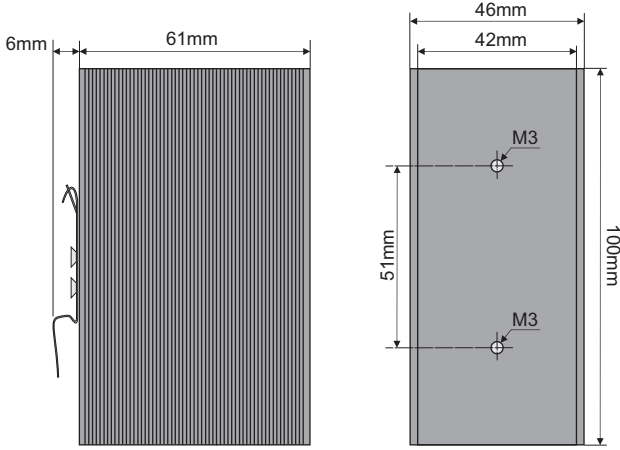

ENDA ETS-46-80

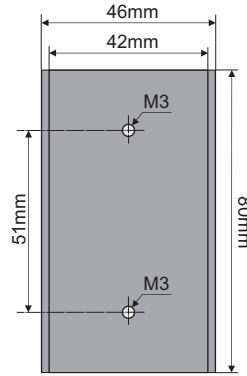

ENDA ETS-46-62

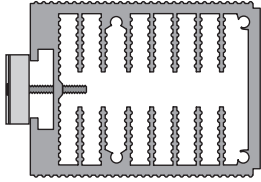
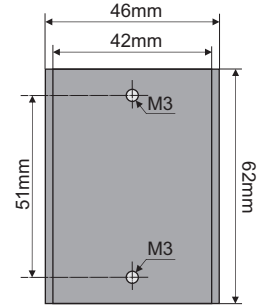

- For removing the device from the panel; Pull up in direction 1
- For mounting the device to the panel; Push down in direction 2

ENDA ETS-46-100F RAIL MOUNTED HEAT SINK

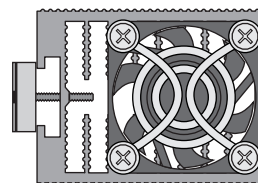
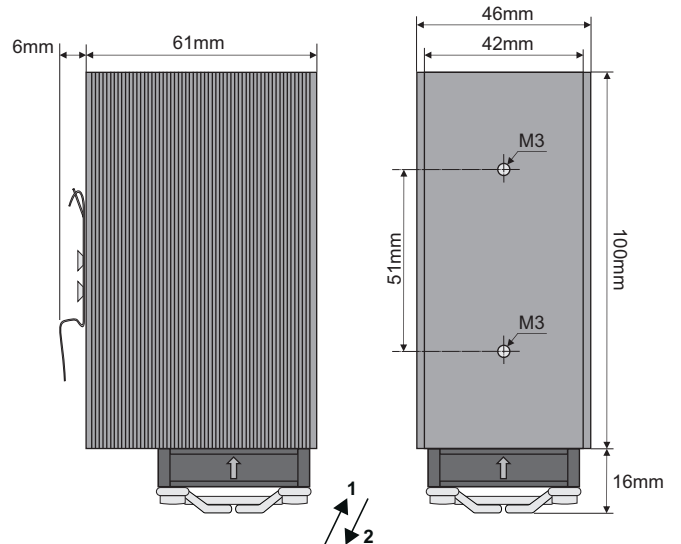

- For removing the device from the panel; Pull up in direction 1
- For mounting the device to the panel; Push down in direction 2

Fan supply : 24VDC, 100mA.
Fan side of the device must be at the bottom.

Heat Sink	SSR Current (A)	Dimensions WxHxD (mm)	Thermal Resistance (°C/W)
ETS-46-62	12-25	46x61x62	2,0
ETS-46-80	20-25	46x61x80	1,7
ETS-46-100	25-40	46x61x100	1,5
ETS-62-100	40-50	62x77x100	1,0
ETS-99-100	3x25	99x87x100	0,75
ETS-46-100F	50-70	46x61x110	0,7
ETS-62-100F	70-120	62x77x120	0,4
ETS-99-100F	3x40 - 3x50	99x87x125	0,34



SİSEL MÜHENDİSLİK ELEKTRONİK SAN. VE TİC. A.Ş.
Şerifali Mah. Barbaros Cad. No:18 Y.Dudullu 34775
ÜMRANIYE/İSTANBUL-TURKEY
Tel : +90 216 499 46 64 Pbx. Fax : +90 216 365 74 01
url : www.enda.com.tr



ENDA ETS-62-100F RAIL AND PANEL MOUNTED HEAT SINK

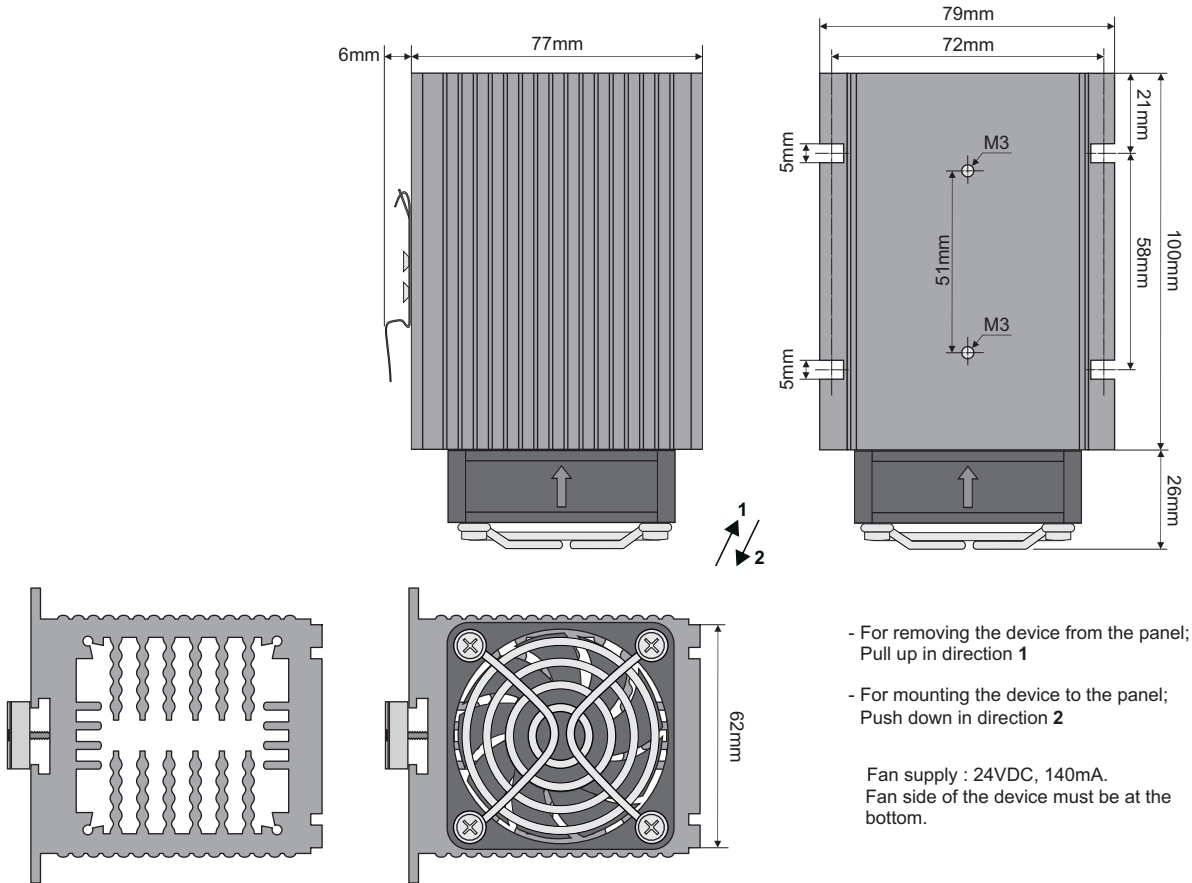

ENDA ETS-99-100F RAIL AND PANEL MOUNTED HEAT SINK

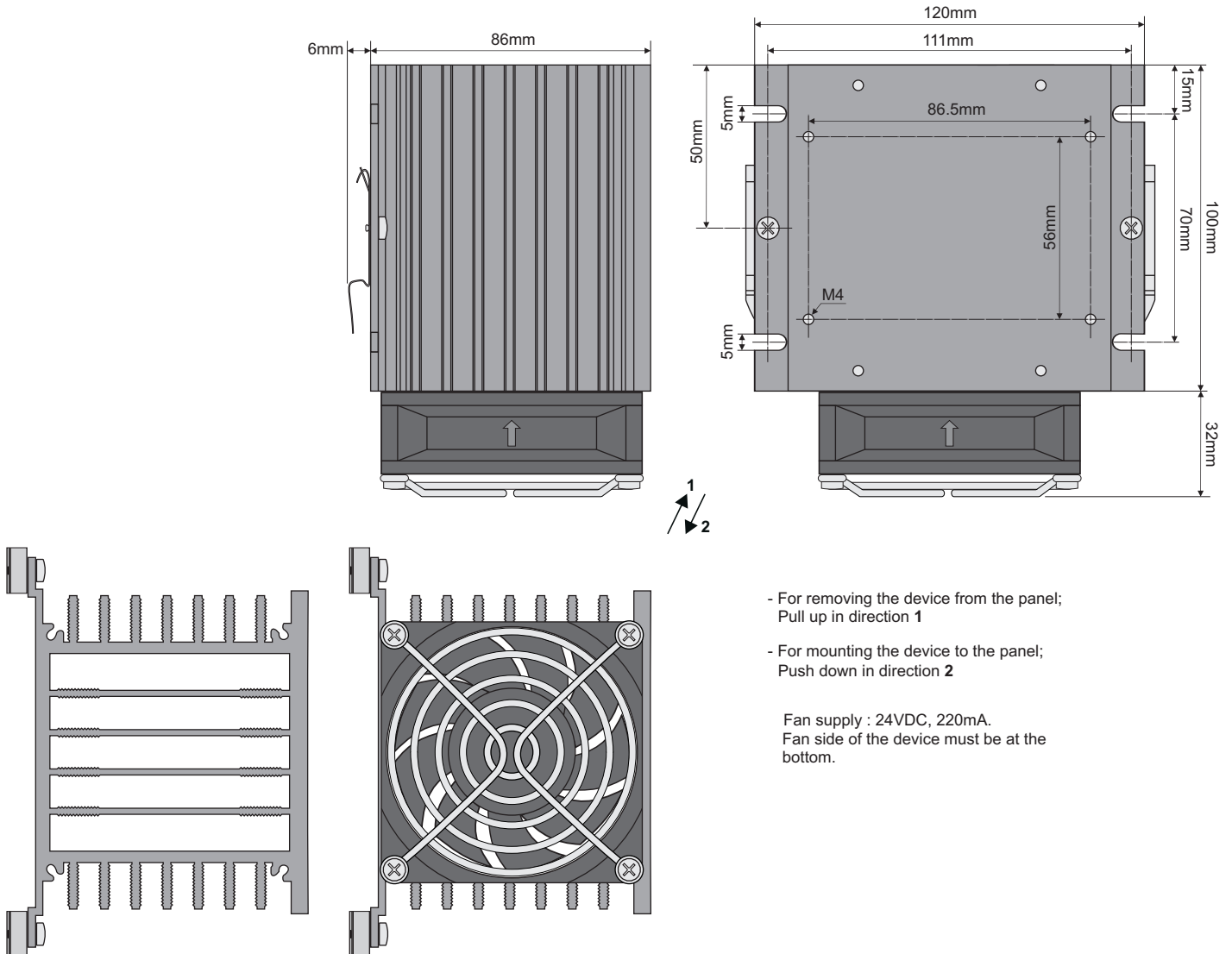

Heat / Current Curves with ETS Series Heat Sinks for ENDA Panel Mounted SSR's

EPxA1-212Z

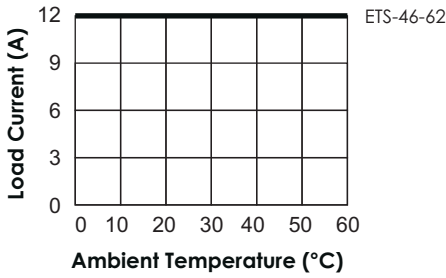

EPxA1-225Z

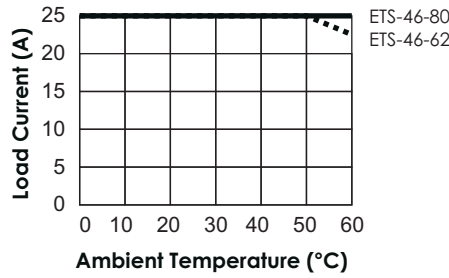

EPxA1-240Z

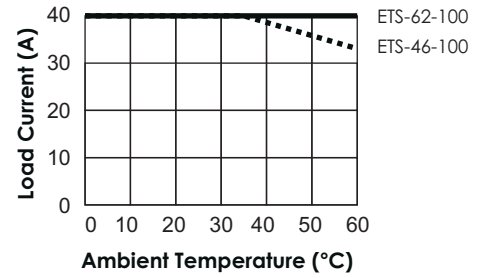

EPxA1-425Z

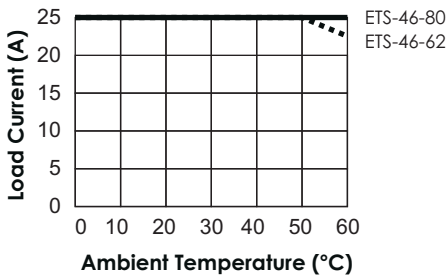

EPxA1-440Z

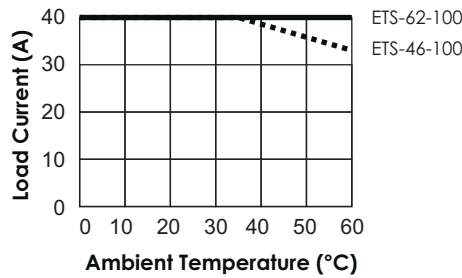

EPxA1-450Z

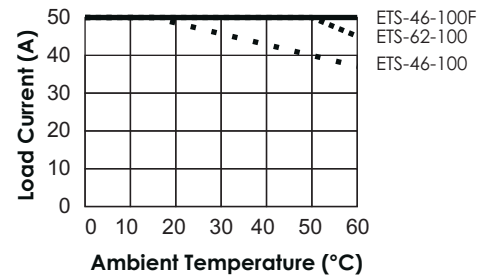

EPxA1-470Z

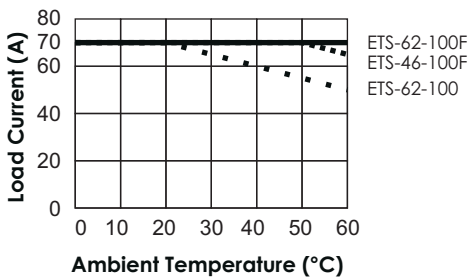

EPxA1-4100Z

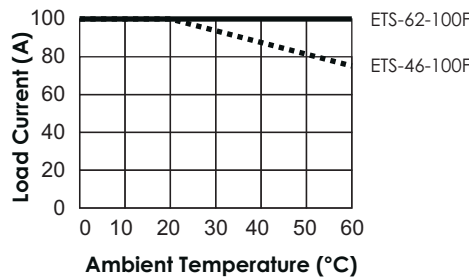

EPxA1-4120Z

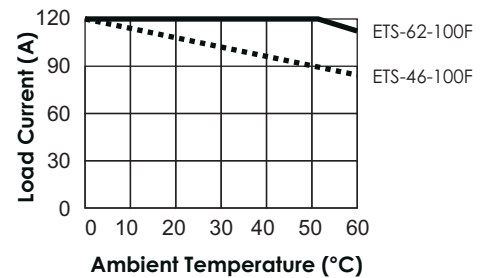

EPxA3-425Z

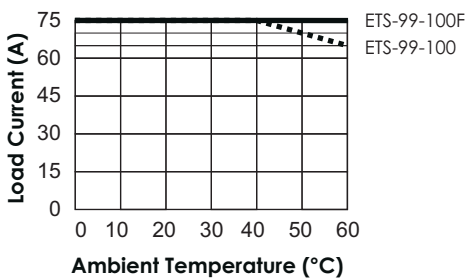

EPxA3-440Z

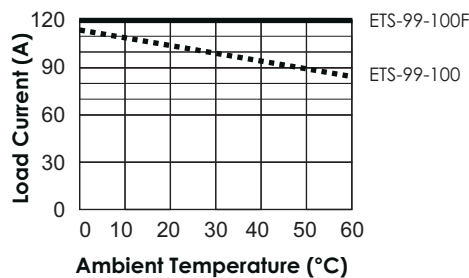

EPxA3-450Z

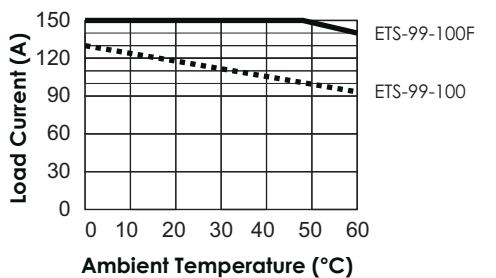

SİSEL MÜHENDİSLİK ELEKTRONİK SAN. VE TİC. A.Ş.
 Şerifali Mah. Barbaros Cad. No:18 Y.Dudullu 34775
 ÜMRANIYE/İSTANBUL-TURKEY
 Tel : +90 216 499 46 64 Pbx. Fax : +90 216 365 74 01
 url : www.enda.com.tr

