

Multifunction time relay JART8- M

Instruction Manual

General



■ Applications

-Multifunction time relay can be used for electrical appliances, control of lights, heating, motors, pumps and fans (10 functions, 10 time ranges, multi-voltage).

■ Function Features

- 10 functions: - 5 time functions controlled by supply voltage
- 4 time functions controlled by control input
- 1 function of latching relay

-Comfortable and well-arranged function and time-range setting by rotary switches.

-Time scale 0.1 s - 10 days divided into 10 ranges.

- Relay status is indicated by LED.

- 1-MODULE, DIN rail mounting.

■ Model and connotation

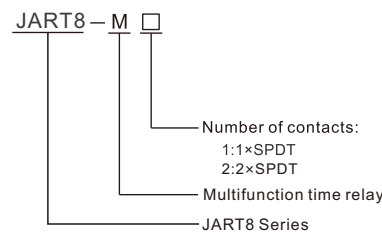

Technical parameters

Technical parameters	JART8-M1	JART8-M2
Function	A,B,C,D,E,F,G,H,I,J	
Supply terminals	A1-A2	
Voltage range	AC/DC 12-240V(50-60Hz)	
Burden	AC 0.09-3VA/DC 0.05-1.7W	
Supply voltage tolerance	-15%;+10%	
Supply indication	green LED	
Time ranges	0.1s-10days,ON,OFF	
Time setting	potentionmeter	
Time deviation	10%-mechanical setting	
Repeat accuracy	0.2%-set value stability	
Temperature coecient	0.05%/°C,at=20°C(0.05%°F, at=68°F)	
Output	1xSPDT	2xSPDT
Current rating	16A/AC1	
Switching voltage	250VAC/24VDC	
Min.breaking capacity DC	500mW	
Output indication	red LED	
Mechanical life	1x10 ⁷	
Electrical life(AC1)	1x10 ⁵	
Reset time	max.200ms	
Operating temperature	-20°C to +55°C (-4°F to 131°F)	
Storage temperature	-35°C to +75°C (-22°F to 158°F)	
Mounting/DIN rail	Din rail EN/IEC 60715	
Protection degree	IP40 for front panel/IP20 terminals	
Operating position	any	
Overvoltage cathegory	III.	
Pollution degree	2	
Max.cable size(mm ²)	solid wire max.1x2.5or 2x1.5/with sleeve max.1x2.5(AWG 12)	
Tightening torque	0.4Nm	
Dimensions	90x18x64mm	
Weight	63g	82g
Standards	EN 61812-1,IEC60947-5-1	

Panel Diagram

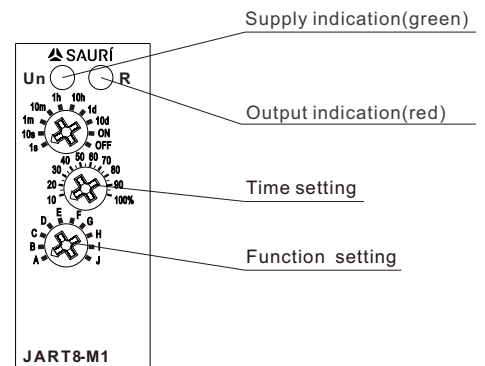

Wiring Diagram

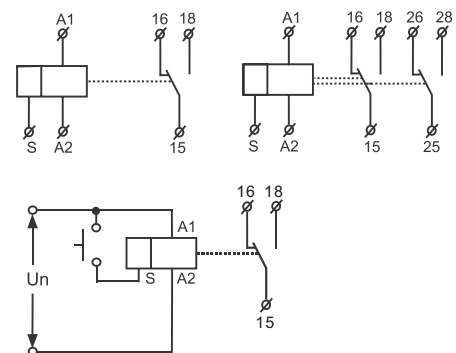

Functions Diagram

A: On Delay (Power On)

When the input voltage U is applied, timing delay t begins. Relay contacts R change state after time delay is complete. Contacts R return to their shelf state when input voltage U is removed. Trigger switch is not used in this function.



B: Interval (Power On)

When input voltage U is applied, relay contacts R change state immediately and timing cycle begins. When time delay is complete, contacts return to shelf state. When input voltage U is removed, contacts will also return to their shelf state. Trigger switch is not used in this function.

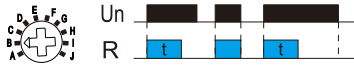

C: Repeat Cycle (Starting Off)

When input voltage U is applied, time delay t begins. When time delay t is complete, relay contacts R change state for time delay t. This cycle will repeat until input voltage U is removed. Trigger switch is not used in this function.



D: Repeat Cycle (Starting On)

When input voltage U is applied, relay contacts R change state immediately and time delay t begins. When time delay t is complete, contacts return to their shelf state for time delay t. This cycle will repeat until input voltage U is removed. Trigger switch is not used in this function.

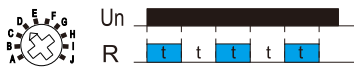

E: Off Delay (S Break)

Input voltage U must be applied continuously. When trigger switch S is closed, relay contacts R change state. When trigger switch S is opened, delay t begins. When delay t is complete, contacts R return to their shelf state. If trigger switch S is closed before time delay t is complete, then time is reset. When trigger switch S is opened, the delay begins again, and relay contacts R remain in their energized state. If input voltage U is removed, relay contacts R return to their shelf state.

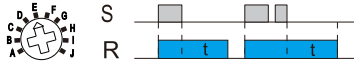

F: Single Shot

Upon application of input voltage U, the relay is ready to accept trigger signal S. Upon application of the trigger signal S, the relay contacts R transfer and the preset time t begins. During time-out, the trigger signal S is ignored. The relay resets by applying the trigger switch S when the relay is not energized.

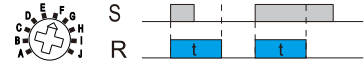

G: Single Shot Trailing Edge (Non-Retriggerable)

Upon application of input voltage U, the relay is ready to accept trigger signal S. Upon application of the trigger signal S, the relay contacts R transfer and the preset time t begins. At the end of the preset time t, the relay contacts R return to their normal condition unless the trigger switch S is opened and closed prior to time-out t (before preset time elapses). Continuous cycling of the trigger switch S at a rate faster than the preset time will cause the relay contacts R to remain closed. If input voltage U is removed, relay contacts R return to their shelf state.

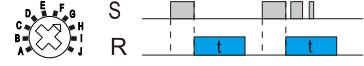

H: On/Off Delay

Input voltage U must be applied continuously. When trigger switch S is closed, time delay t begins. When time delay t is complete, relay contacts R change state and remain transferred until trigger switch S is opened. If input voltage U is removed, relay contacts R return to their shelf state.

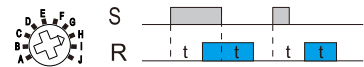

I: Latching relay

Input voltage U must be applied continuously. Output changes state with every trigger switch S closure. If input voltage U is removed, relay contacts R return to their shelf state.



J: Pulse generator

Upon application of input voltage U, a single output pulse of 0.5 seconds is delivered to relay after time delay t. Power must be removed and re-applied to repeat pulse. Trigger switch is not used in this function.

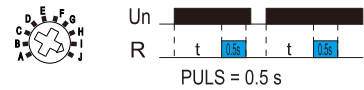

Dimensions(mm)

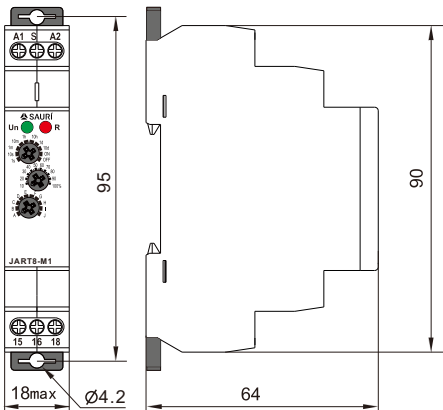

Setting instructions

	Knob 1: delay gear setting, "s" for second, "m" for minute, "h" for hour, "d" for day, "ON" for relay action (15-18/25-28 closed), "OFF" for relay open (15-18/25-28 open).
	Knob 2: fine adjustment of delay time, 10% ~ 100% adjustable.
<p>Delay time = knob 1 × knob 2.</p> <p>Example 1: it needs to be set for 5 seconds. You can set knob 1 to 10s, knob 2 to 50%, and delay time = 10s × 50% = 5s.</p> <p>Example 2: it needs to be set for 8 minutes. You can set knob 1 to 10m, knob 2 to 80%, and delay time = 10m × 80% = 8m.</p>	



Disposal of Electrical Waste
All electrical waste should be disposed of in compliance with current WEEE regulations.



Caution

The products must be installed by qualified electricians. All and any electrical connections of the product shall comply with the appropriate safety standards.