

# Level control relay JARL8 Instruction Manual

## General



- Applications
  - Designed for monitoring level in wells, basins, reservoirs, tanks.....
- Function Features
  - In one device you can choose the following configurations:
    - 2 level control mode
    - 1 level control mode
  - Choice of function PUMP UP, PUMP DOWN.
  - Adjustable time delay on the output (0.1 - 10s).
  - Sensitivity adjustable by a potentiometer (5-100kΩ).
  - Galvanically separated supply voltage AC/DC 24-240V.
  - Relay status is indicated by LED.
  - 1-MODULE, DIN rail mounting.

### Model and connotation

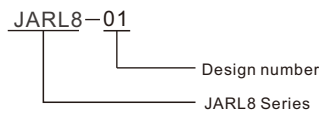

## Technical parameters

Technical parameters	JARL8-01	JARL8-02
Function	2 level control mode	2 or 1 level control mode
Supply terminals	A1-A2	
Voltage range	AC/DC 24-240V(50-60Hz)	
Input	max.2VA	
Supply voltage tolerance	-15%;+10%	
Sensitivity (input resistance)	adjustable in range 5 kΩ - 100 kΩ	
Voltage in electrodes	max. AC 5 V	
Current in probe	AC <0.1 mA	
Time response	max. 400 ms	
Max. capacity length	800 m (sensitivity 25kΩ), 200 m (sensitivity 100 kΩ)	
Max. capacity of probe cable	400 nF (sensitivity 25kΩ), 100 nF (sensitivity 100 kΩ)	
Time delay (t)	adjustable, 0.1 - 10 s	
Accuracy in setting (mechanical)	±10 %	
Temperature coefficient	0.05%/°C, at=20°C(0.05%/°F, at=68°F)	
Output	1×SPDT	
Current rating	10A/AC1	
Switching voltage	250VAC/24VDC	
Min. breaking capacity DC	500mW	
Output indication	red LED	
Mechanical life	1×10 <sup>7</sup>	
Electrical life(AC1)	1×10 <sup>5</sup>	
Reset time	max.200ms	
Operating temperature	-20°C to +55°C (-4°F to 131°F)	
Storage temperature	-35°C to +75°C (-22°F to 158°F)	
Mounting/DIN rail	Din rail EN/IEC 60715	
Protection degree	IP40 for front panel/IP20 terminals	
Operating position	any	
Overvoltage category	III.	
Pollution degree	2	
Max. cable size (mm <sup>2</sup> )	solid wire max.1×2.5or 2×1.5/with sleeve max.1×2.5(AWG 12)	
Tightening torque	0.8Nm	
Dimensions	90×18×64mm	
Weight	70g	72g
Standards	EN 62055-1	

## Panel Diagram

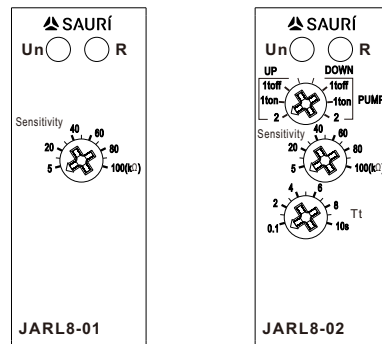

## Wiring Diagram

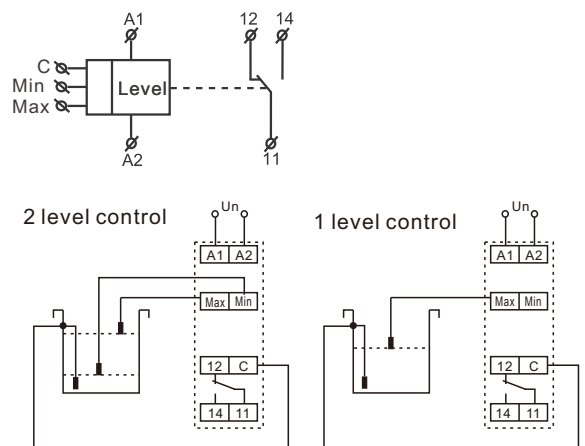

# Functions Diagram

**JARL8-01** 2 level control

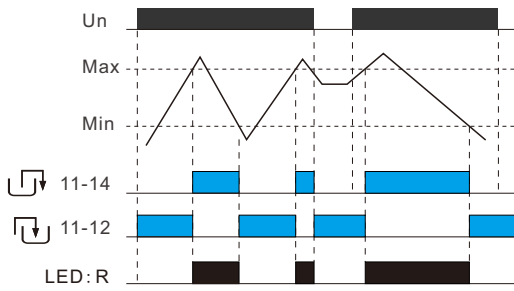

**JARL8-02** 2 level control(pump up/down)

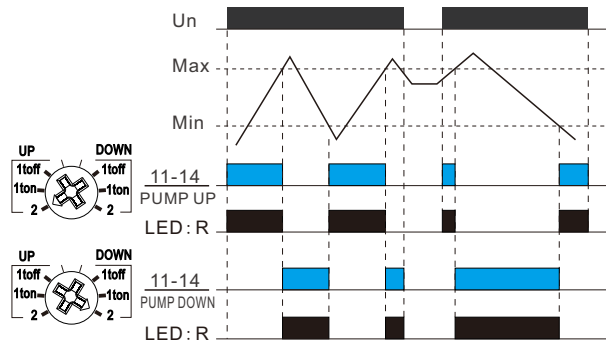

1 level control(pump up t on)

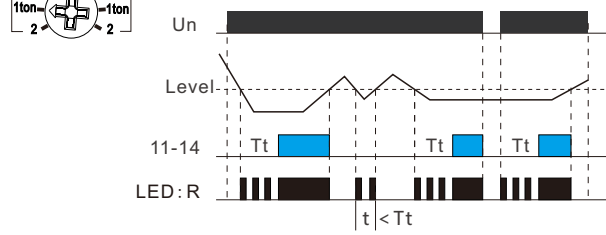

1 level control(pump up t off)

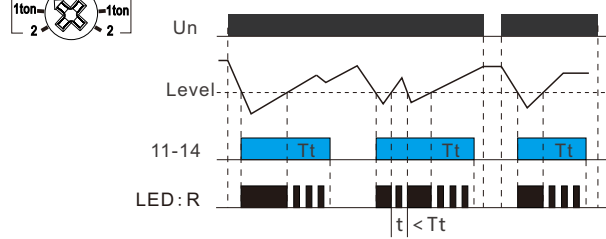

1 level control(pump down t on)

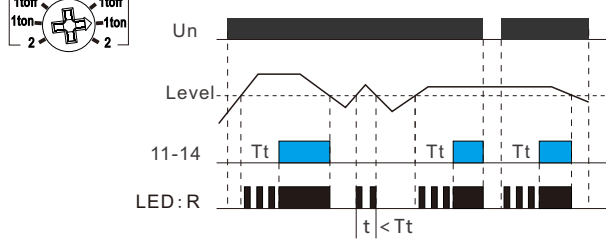

1 level control(pump down t off)

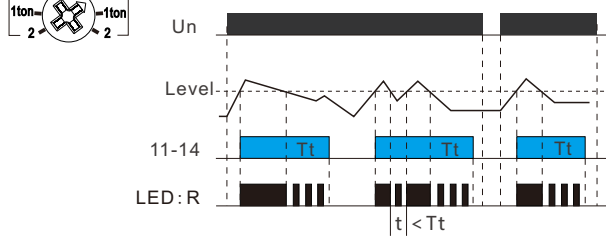

## Dimensions(mm)

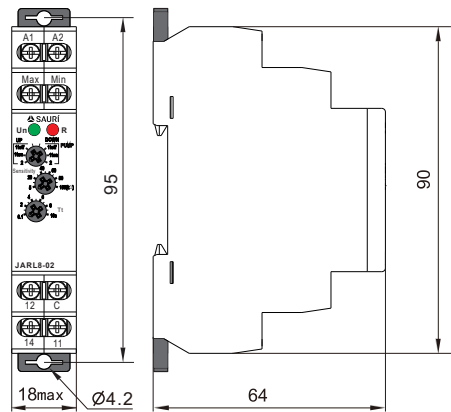

**Disposal of Electrical Waste**  
All electrical waste should be disposed of in compliance with current WEEE regulations.



**Caution**  
The products must be installed by qualified electricians. All and any electrical connections of the product shall comply with the appropriate safety standards.